



User's Manual

H8030

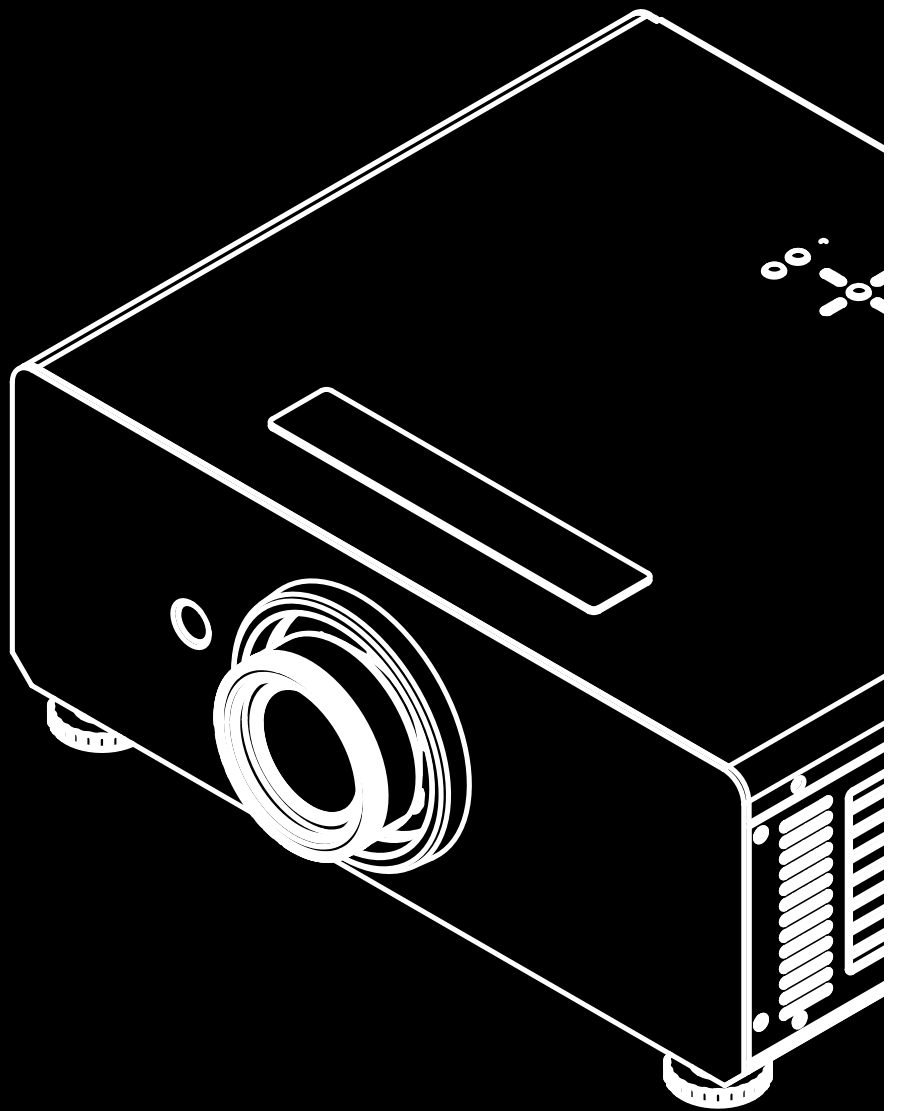

Table of Contents

COPYRIGHT INFORMATION	4
IMPORTANT SAFETY INSTRUCTIONS	5
DISPOSAL OF OLD ELECTRICAL AND ELECTRONIC EQUIPMENT	6
Important Recycle Instructions	6
INTRODUCTION	7
About This Manual	7
Description, Features and Benefits	7
Parts List	8
CONTROLS AND FUNCTIONS	9
H8030 at a Glance	9
I/O Panel	10
KEYPAD	11
LED Indicator	11
REMOTE CONTROL	12
INTALLATION	13
To install batteries in the remote	13
Range of effective remote control signal reception	13
Installation Considerations	14
Ambient Light	14
Throw Distance	14
Modes of installation	15
Allow at least 50 cm clearance around the exhaust vent	16
Do not tilt the projector more than 15 degrees	16
Other Considerations	16
Lens Shift	17
Vertical Lens Shift	17
Horizontal Lens Shift	17
Connecting the projector to other devices	18
HDMI Connection	18
12V Trigger connection	18
IR Input connection	19
S-VIDEO, VIDEO connection	19
COMPONENT connection	20
RS-232 Controller Connection	20
Start using the projector – Adjustments	21
Connecting to AC Power	21
Turning on the Power	21
Changing the OSD Language	22
Adjusting the Picture Orientation	22
Mechanical Adjustments	23
Operation	24
Selecting an Input Source	24
Selecting an Aspect Ratio	24

Selecting Video Memory24

Using the On-Screen Menus (OSD)25

Start using the projector - OSD Introduction.....26

 OSD Menu Tree26

 OSD Introduction – MAIN27

 OSD Introduction – ADVANCE.....32

 OSD Introduction – SYSTEM.....35

 OSD Introduction - CONTROL.....36

 OSD Introduction – LANGUAGE37

 OSD Introduction – SERVICE.....37

Change Lamp.....39

 To replace the projector lamp.....39

Maintenance and Troubleshooting40

Serial Communications.....41

RS-232 Error Codes.....48

Specifications49

 H8030 Specifications49

 H8030 Specifications (continued)50

 Reliability.....50

 Standard Accessories50

Dimensions51

Supported Timings.....52

About the Vivitek Support53

COPYRIGHT INFORMATION

Copyright

This publication, including all photographs, illustrations and software, is protected under international copyright laws, with all rights reserved. Neither this manual, nor any of the material contained herein, may be reproduced without written consent of the manufacturer. The Vivitek logo is a trademark of "Vivitek Corporation." © Copyright 2015.

Disclaimer

The information in this document is subject to change without notice. The manufacturer makes no representations or warranties with respect to the contents hereof and specifically disclaims any implied warranties of merchantability or fitness for any particular purpose. The manufacturer reserves the right to revise this publication and to make changes from time to time in the content here without obligation of the manufacturer to notify any person of such revision or changes.

About this manual

This manual is intended for end users and describes how to install and operate the DLP projector. Wherever possible, relevant information such as an illustration and its description has been kept on one page. This printer-friendly format is both for your convenience and to help save paper, thereby protecting the environment. It is suggested that you only print sections that are relevant to your needs.

IMPORTANT SAFETY INSTRUCTIONS

Thank you for your purchase of this quality product! For best performance, please read this manual carefully as it is your guide through the menus and operation.

1. Read and Keep these instructions.
2. Heed all warnings.
3. Follow all instructions.
4. Do not use this apparatus near water, and not install near any heat sources such as radiators, heat registers, stoves, or other apparatus (including amplifiers) that produce heat.

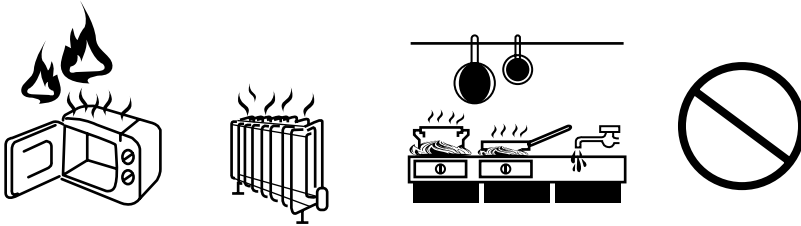

5. Clean only with a dry cloth.
6. Do not block any of the ventilation openings. Install in accordance with the manufacturer's instructions.
7. Do not defeat the safety purpose of the polarized or grounding type plug. A polarized plug has two blades with one wider than the other. A grounding type plug has two blades and a third grounding prong. The wide blade or the third prong is provided for your safety. When the provided plug does not fit into your outlet, consult an electrician for the replacement of the obsolete outlet.
8. Protect the power cord from being walked on or pinched particularly at plugs, convenience receptacles and the point where they exit from the apparatus.
9. Only use the attachments/accessories specified by the manufacturer.
10. Use only with a cart, stand, tripod, bracket or table specified by the manufacturer or sold with the apparatus. When a cart is used, use caution when moving the cart/ apparatus to avoid injury from tip-over.



11. Unplug this apparatus during lightning storms or when unused for long periods of time.

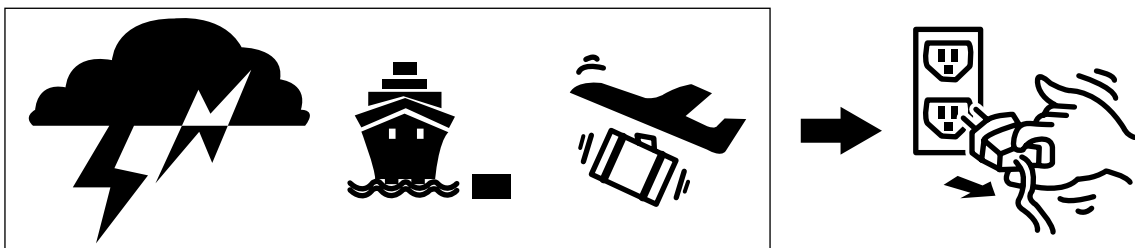

12. Refer all servicing to qualified service personnel. Servicing is required when the apparatus has been damaged in any way, such as power supply cord or plug is damaged, liquid has been spilled or objects have fallen into the apparatus, the apparatus has been exposed to rain or moisture, does not operate normally, or has

been dropped.

13. The +12V trigger only outputs 12V DC signal for triggering. Do not connect to any other power input or output. This could cause damage to this unit.
14. Keep the packing material in case the equipment
15. Never look into the lens when the projector is on.

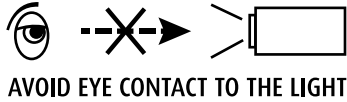

DISPOSAL OF OLD ELECTRICAL AND ELECTRONIC EQUIPMENT

(Applicable throughout the European Union and other European countries with separate collection programs)

This symbol found on your product or on its packaging, indicates that this product should not be treated as household waste when you wish to dispose of it. Instead, it should be handed over to an applicable collection point for the recycling of electrical and electronic equipment. By ensuring this product is disposed of correctly, you will help prevent potential negative consequences to the environment and human health, which could otherwise be caused by inappropriate disposal of this product. The recycling of materials will help to conserve natural resources. This symbol is only valid in the European Union. If you wish to discard this product, please contact your local authorities or dealer and ask for the correct method of disposal.

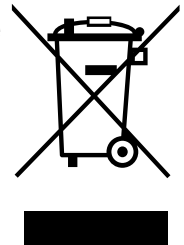

Important Recycle Instructions

Lamp(s) inside this product contain mercury. This product may contain other electronic waste that can be hazardous if not disposed of properly. Recycle or dispose in accordance with local, state, or federal Laws. For more information, contact the Electronic Industries Alliance at WWW.EIAE.ORG For lamp specific disposal information check WWW.LAMPRECYCLE.ORG



INTRODUCTION

About This Manual

This User's Manual describes how to install, set up and operate the H8030. Throughout this manual, the Projector is referred to as the "H8030."

Vivitek has prepared this manual to help installers and end users get the most out of the H8030. Vivitek has made every effort to ensure that this manual is accurate as of the date it was printed. However, because of ongoing product improvements and customer feedback, it may require updating from time to time. You can always find the latest version of this and other Vivitek product manuals on-line, at www.vivitekcorp.com.

Description, Features and Benefits

The Vivitek H8030 provides state-of-the-art technology for 1080P picture performance, native resolution for crystal clear, pristine images. The H8030 features optional high performance lens. These precision optics allow for picture size optimization in the majority of installations. Exceptional scaling and film-to-video (3:2 pull-down) conversion is easily achieved. Combined with Vivitek's sophisticated parameters for white balancing, the H8030's proprietary de-interlacing technology provides the highest level of development for gray-scale and color balancing and artifact-free images. The H8030 also features ease of use operation by utilizing discreet infrared (IR) and RS-232 commands from a control system.

■ Key Features and Benefits

The H8030 offers these key features and benefits:

- Native Resolution: 1920 x 1080 pixels (16:9 Native Aspect Ratio).
- DLP system using high-performance Digital Micromirror Device (DMD).
- Two (2), HDMI 1.3 Inputs with High-bandwidth Digital Content Protection (HDCP).
- HDTV Compatible .
- Excellent Video Processing on progressive and interlaced video inputs.

■ Green Product with:

- Lead free solder used for soldering including circuit and component electronics.
- Lead free glasses and coatings.
- Recycled paper used in the user manuals and packing cartons.
- Energy Saving: High efficiency power switching and less than 1W power consumption in standby mode.

■ Additional Features of the H8030

- Horizontal and vertical lens shift.

Parts List

Your H8030 is shipped with the following items, if any items are missing or damaged, please contact your.

- Power Cable USA x 1
- HDMI Cable x 1
- DLP Projector x 1
- Wrench x 1
- Remote Control x1
- Batteries x 2
- CD x 1
- Warranty Card USA x 1
- Standard Lens throw range (1.85 to 2.40:1)

Note: *The H8030 has multiple lens options. Please check product brochure or datasheet for more info.*

CONTROLS AND FUNCTIONS

H8030 at a Glance

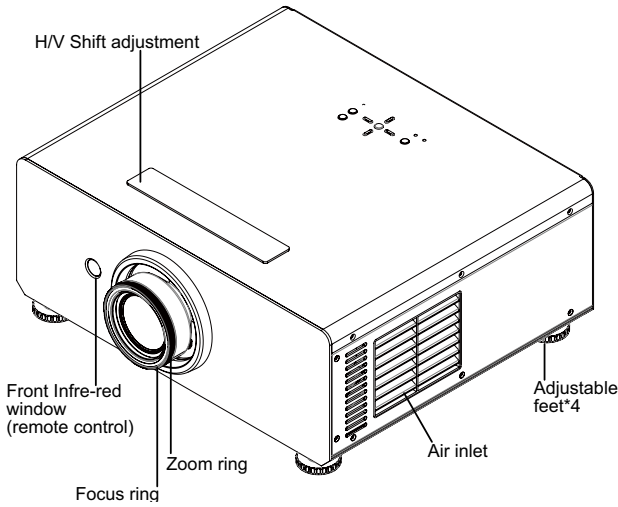

- **Vertical and Horizontal Shift adjustment**
Refer to *Page 23 --- Mechanical Adjustments*
- **Focus Ring**
Rotate this to focus the projected image.
- **Zoom Ring**
Rotate this to change the projected image size.
- **Air Inlet**
Internal fans draw cool air into the projector through this vent.
- **Adjustable feet**
Use these when the projector is installed in a table-top configuration to level the image and/or adjust the projection angle
- **Front Infrared Window**
Remote control IR receiver

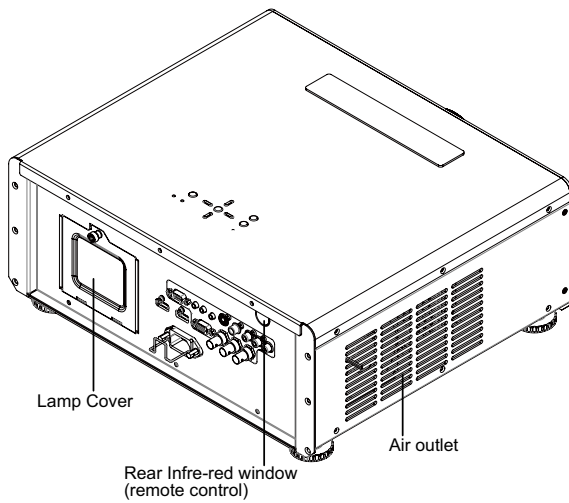

- **Lamp Cover**
Refer to *Page 39 --- Change Lamp*
- **Rear Infrared Window**
Remote control rear IR receiver
- **Air outlet**
Warm air exits the projector through this vent. Ensure that it is not blocked

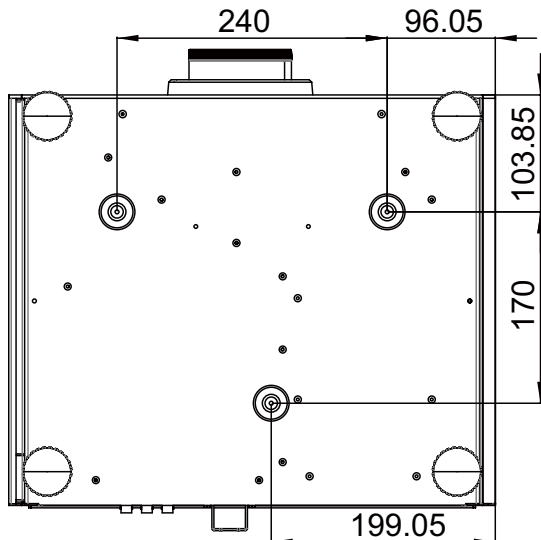

- **M4xL10**
Use screw x 3pcs (M4, Length=10mm) for ceiling mount.

I/O Panel

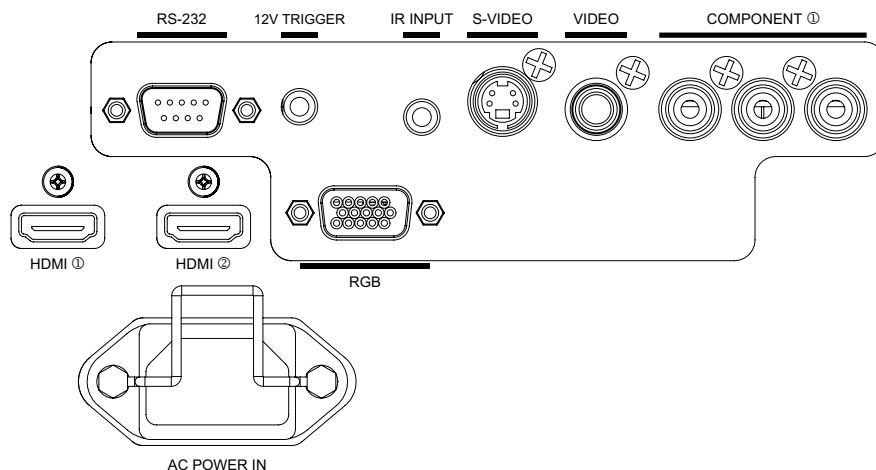

- **TRIGGER**
(3.5-mm, mini phone jack) Offers 12 (+/- 1.5) V of output for 350mA monitor relay protection.
- **IR INPUT**
Wired input from a Niles- or Xantech-compatible, infrared (IR) repeater system.
- **S-VIDEO**
A standard S-Video input for connecting a DVD player, satellite receiver or Super VHS (S-VHS) VCR.
- **VIDEO**
Standard composite video input for connecting a VCR, laser disc player or other composite video source. Also pro-vides composite sync input for RGBS sources.
- **COMPONENT (RCA connectors)**
Standard or high-definition (480i/480p/576i/576p/720p/1080i/1080p) Component (YPbPr) input for connecting a DVD/HD-DVD/BD player, HD set-top box or other SD/HD source. Also provides RGB input for RGBS sources.
- **RGB**
Provides a standard, 15-pin VGA-style connection to either an RGB or component high-definition source, or to a personal computer. The H8030 automatically detects the input signal resolution.
- **HDMI1, HDMI2**
For connect the device which have HDMI output connectors.
- **AC Power In**
For input AC power from the wall to the projector Inlet.

REMOTE CONTROL

① Status LED Power Buttons:

Use these buttons to turn the projector on (⏻) or off (⏻).

② Source Selection Buttons (1-5):

Press to select a video source. By default, these buttons are signed as follows:

1 = HDMI 1; 2 = HDMI 2; 3 = Component 1;
4 = S-Video; 5 = Video.

However, you can assign each button to any source you wish. When you assign a source to a numbered key, the projector immediately goes to that source. If the chosen source is disabled via the Source Enable menu, this setting has no effect.

③ Cursor Keys (▲▼◀▶)

Use these buttons to select items or settings, adjust settings or switch display patterns.

ENTER

Press to select a highlighted menu item or confirm a changed setting.

④ Aspect Ratio Selection Button

Press this button repeatedly to select one of the following aspect ratios:

16 : 9: For viewing 16:9 DVDs or HDTV programs in their native aspect ratio.

Letterbox: For viewing LaserDisc movies or non-anamorphic DVDs on a 16:9 screen.

4 : 3: Scales the input signal to fit 4:3 sources in the center of the screen.

4:3 Narrow: Scales the input signal to fit 4:3 sources in the center of the screen when using an anamorphic lens.

Native: Displays source image in its native resolution without re-sizing or overscan.

⑤ MENU

Press this button to show or hide the OSD controls.

⑥ Memory Preset Buttons (A / B / C)

Press to recall settings for the current input from one of three memory presets. By default, these buttons are assigned as follows: A = User Memory A; B = User Memory B; C = User Memory C.

⑦ Picture Adjustment Buttons:

Contrast (☉): Press to adjust white level.

Brightness (☉): Press to adjust black level.

Sharpness (SHARP): Press to adjust sharpness.

Gamma (GAMMA): Press to select a gamma curve.

Overscan (O-SCAN): Press to select an overscan mode.

Noise Reduction (NR): Press to adjust noise reduction level.

Brilliant Color (BRI-C): Press to adjust brilliant color.

Color Temperature (C-TEMP): Press to adjust color temperature.

Test Patterns (TEST): Press to activate test patterns.

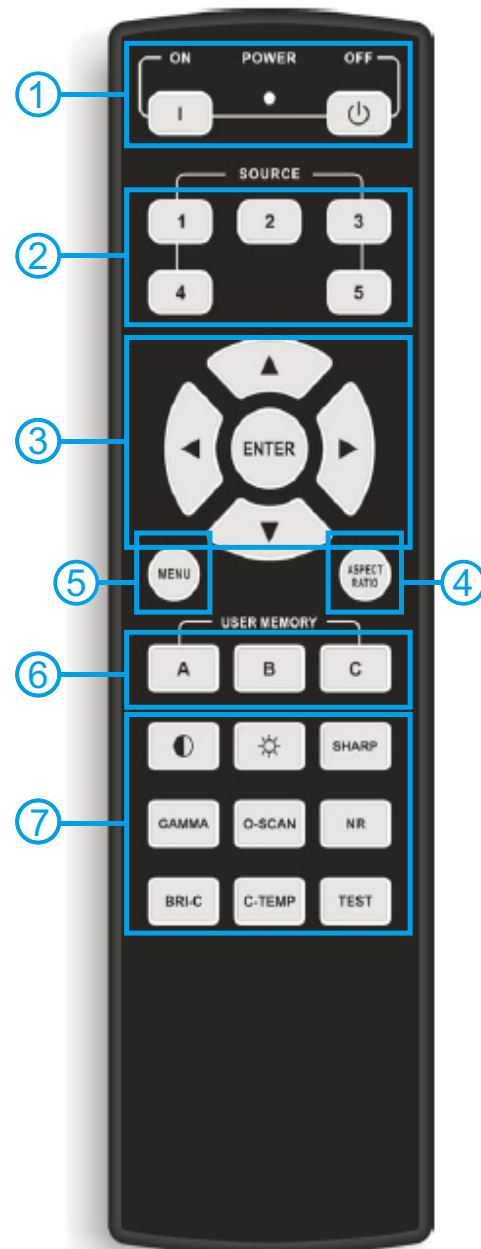

INSTALLATION

To install batteries in the remote

1. Slide the battery compartment cover in the direction of the arrow to remove it.
2. Install two AA batteries with the correct polarity.
3. Replace the cover.

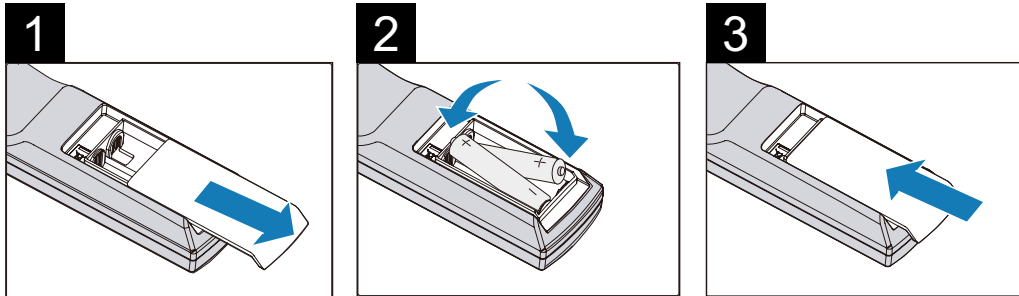

Note on Batteries

- Make sure that the battery polarities are correct when installing the batteries
- Do not mix an old battery with a new one or different types of batteries.
- If you will not use the remote control for a long time, remove the batteries to avoid damage from battery leakage.

Notes on Remote Control Operation

- In most situations, you can simply point the remote control at the screen which will reflect the IR signal from the remote back toward the IR receiver on the projector. In some cases, however, ambient conditions may prevent this. If so, point the remote control at the projector and try again.
- If the effective range of the remote control decreases, or it stops working, replace the batteries with new ones.
- The remote control may fail to operate if the infrared remote sensor is exposed to bright sunlight or fluorescent lighting.

Range of effective remote control signal reception

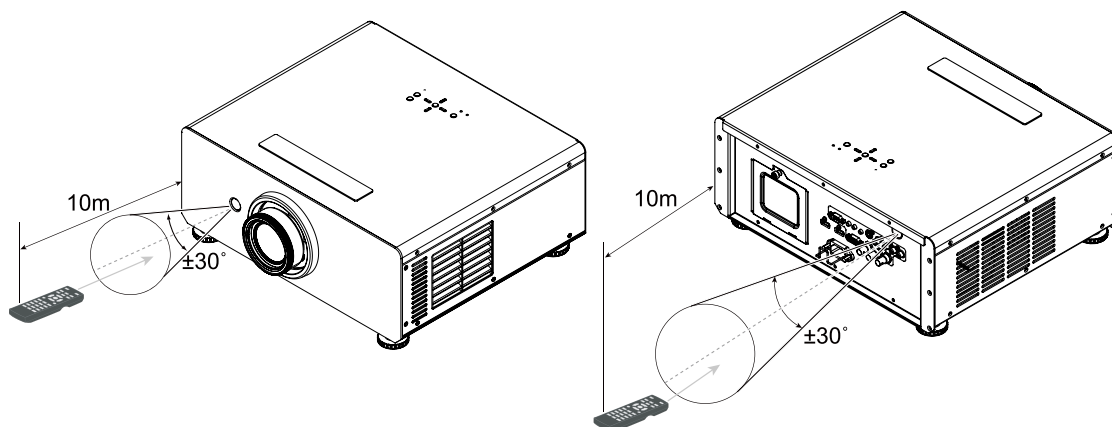

- IR Reception effective Angles: 30°
- IR Reception effective distance: 10m

Note:

Avoid placing the remote control at places of high temperature or humidity as it could cause the remote control to malfunction

Installation Considerations

Proper installation of your projector will ensure the quality of your display. Whether you are installing a projector temporarily or permanently, you should take the following into account to ensure your projector performs optimally.

Ambient Light

In general, minimize or eliminate light sources directed at the screen. Contrast ratio in your images will be noticeably reduced if light directly strikes the screen, such as when a shaft of light from a window or floodlight falls on the image. Images may then appear washed out and less vibrant.

Requires separate room Installation cost is usually higher.

Throw Distance

Throw distance is the distance measured from the front of the projector to the screen. This is an important calculation in any projector installation as it determines whether or not you have enough room to install your projector with a de-sired screen size and if your image will be the right size for your screen. You can quickly estimate the throw distance by taking the width of the screen and multiplying it by the lens throw ratio; see Figure 3-2. The result of this calculation tells you roughly how far back the projector should be positioned from the screen in order to project a focused image large enough to fill the screen.

$$\text{Throw Distance (TD)} = \text{Screen Width (W)} \times \text{Throw Ratio (TR)}$$

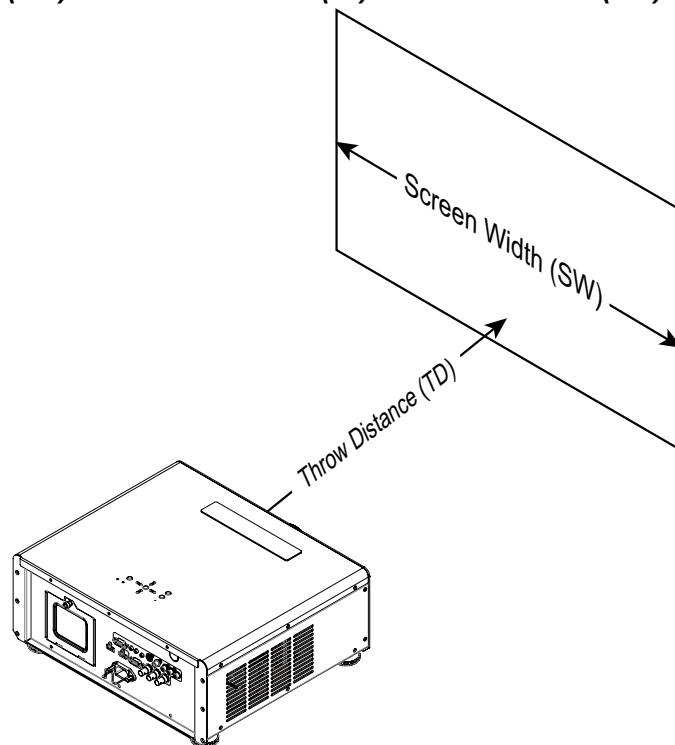

Note:

H8030 is available with multiple lens options. The standard H8030 offers throw ratios between 1.85:1 - 2.40:1. With the optional, short-throw lens with throw ratios between 1.56:1 - 1.86:1, and long-throw lens with throw ratios between 2.40:1 – 4.0:1.

Modes of installation

<p>■ Frontal projection - desktop installation</p> <p>Advantages: Easy to install can be easily moved or adjusted easy to operate.</p> <p>Disadvantage: Occupies floor space and limits seating capacity.</p>	
<p>■ Rear projection - desktop installation</p> <p>Advantage: The projector is completely hidden from plain view the projector can be easily operated this setup usually offers better reduction of ambient noise.</p> <p>Disadvantage: Requires an additional room for installation relatively higher costs for installation.</p>	
<p>■ Frontal projection - ceiling mode</p> <p>Advantage: Does not occupy floor space does not draw attention to it. Eliminates the possibility that someone would accidentally move the projector.</p> <p>Disadvantage: Stricter installation requirements and conditions; care should be taken during the installation to ensure the projector has been securely mounted. Operation of the projector becomes inconvenient without the remote control.</p>	
<p>■ Rear projection - ceiling mode</p> <p>Advantage: The projector is completely hidden from plain view this setup usually offers better reduction of ambient noise.</p> <p>Disadvantage: Requires an additional room for installation. Stricter installation requirements and conditions; care should be taken during the installation to ensure the projector has been securely mounted. Operation of the projector becomes inconvenient without the remote control.</p>	

Allow at least 50 cm clearance around the exhaust vent

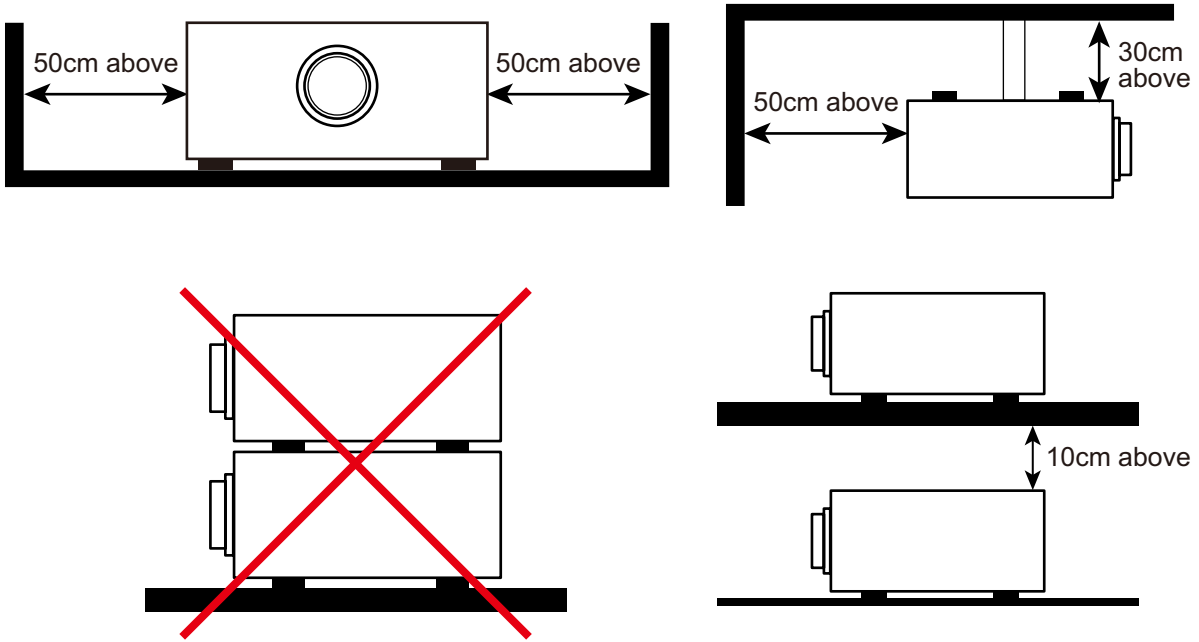

Do not tilt the projector more than 15 degrees

The maximum tilt angle for the projector is 15 degrees.

When the projector is tilted more than 15 degrees, it will shorten the life of the projector lamp and may lead to other unpredictable damages.

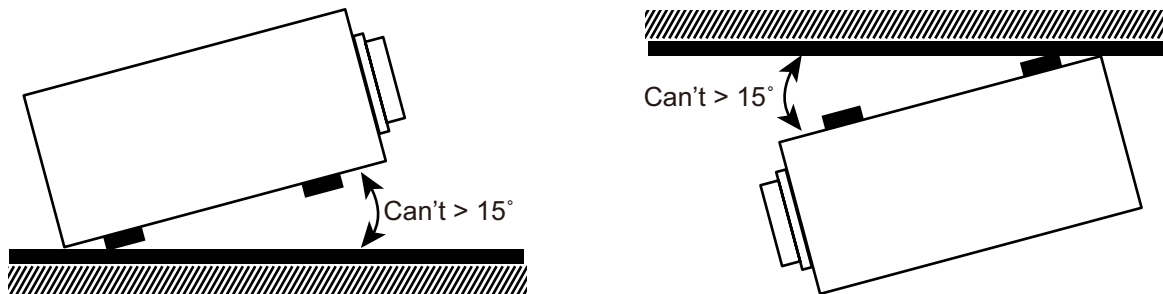

Other Considerations

- Install the projector in an environment below 35°C (95°F). The projector should be kept clear from sources of heat and / or ventilation openings of air conditioner.
- The projector should be kept away from devices that emit electromagnetic energy, such as motor and transformer. Common devices that emit electromagnetic energy include slideshow system, speakers, power amplifiers and elevators.
- If you choose to install the projector on the ceiling, be sure to use the ceiling installation components manufactured by manufacturer-certified vendors. For details, please contact your local dealer.
- Ensure that the intake vents do not recycle hot air from the exhaust vent.

Lens Shift

Vertical Lens Shift

The H8030 has a lens shift capability which allows the vertical movement of the image without moving the projector. Lens shift is generally expressed as a percentage of the screen height. For ceiling mounted projectors, the lens can be moved 120% (0.6V) downward, while the lens can be moved 120% (0.6V) up or down on a desktop mounted projector.

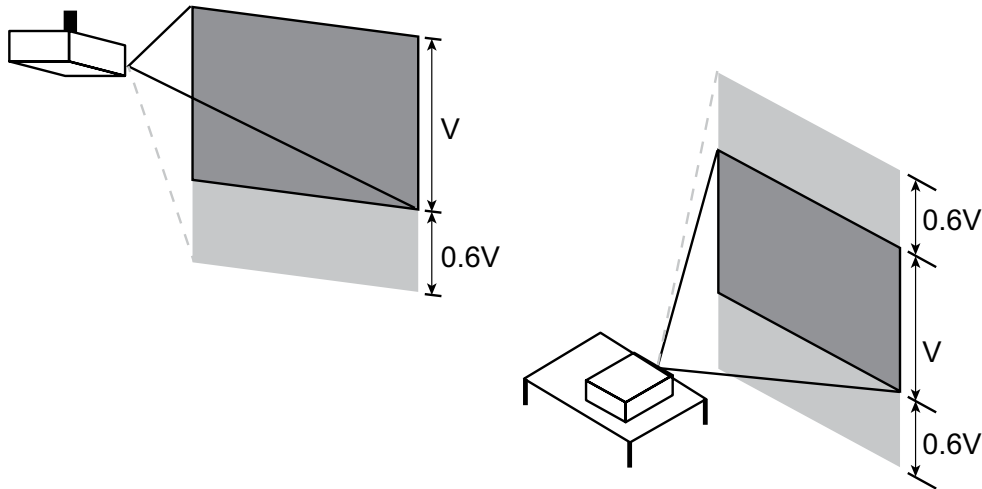

Horizontal Lens Shift

The H8030 has a lens shift capability which allows the horizontal movement of the image without moving the projector. The lens can be moved 30% ($0.15H$) to the right or left within the housing.

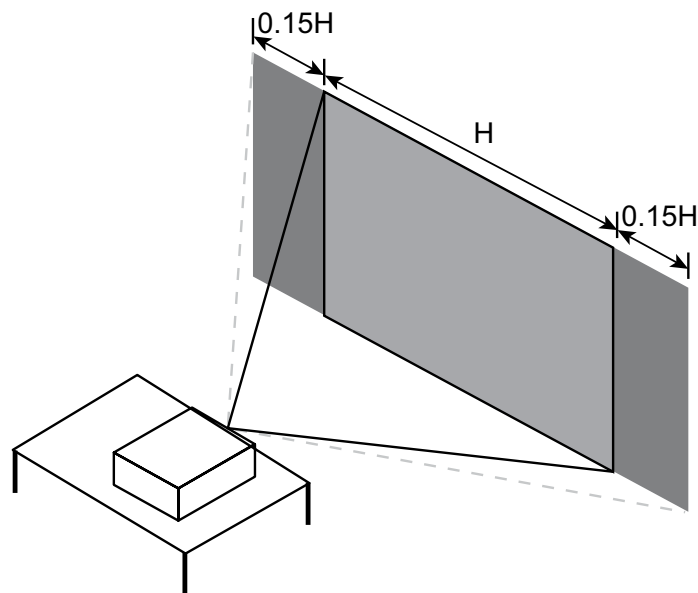

Note:

This is a general example of lens shift. Lenses vary in their shift capabilities. No particular lens or projector is used in this example.

Connecting the projector to other devices

HDMI Connection

Proceed as follows to connect the H8030 to your video sources, external controller(s) - if present - and AC power. When connecting your equipment: •Use the correct signal cables for each source. •Ensure that the cables are securely connected. Tighten the thumbscrews on connectors that have them. Connecting Source Components to the H8030 Connect your video sources to the H8030 as shown and described in the sections that follow.

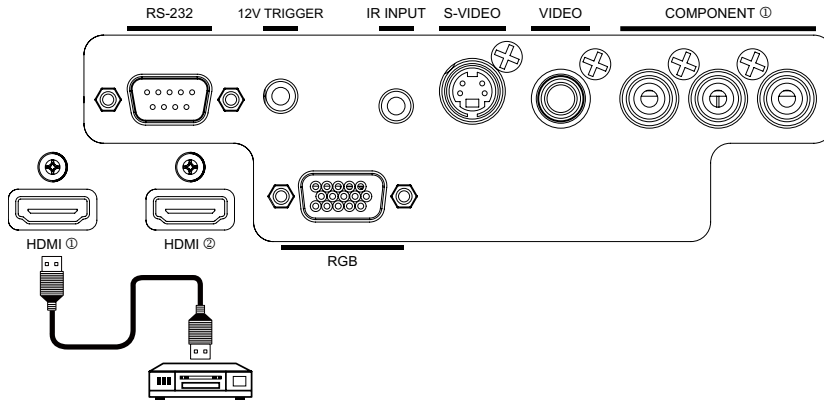

12V Trigger connection

If your home theatre system includes a projector screen, screen cover or other 12V Trigger equipment, please connect such device/equipment to the projector's 12V Trigger output as illustrated. After you have done so, your screen will lower automatically whenever you turn on your projector for your convenience.

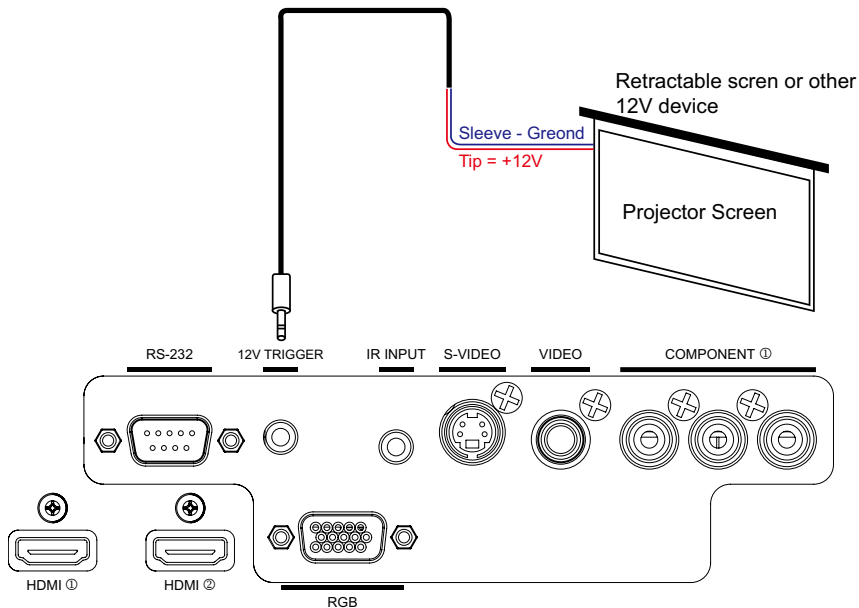

IR Input connection

If infrared signals from the remote control cannot reach the projector due to excessive distance or obstructions such as walls or cabinet doors, you can connect an external IR repeater system to the IR INPUT on the H8030 to extend the range of the remote control.

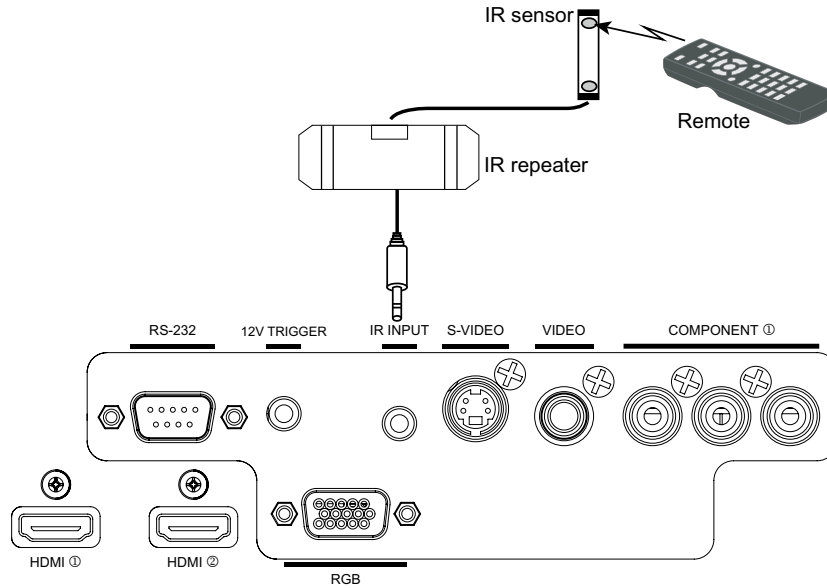

S-VIDEO, VIDEO connection

If the image input device offers both S-Video and Video connection, it is recommended that you choose S-Video to obtain better image quality. If both the S-Video and Video inputs are connected to the projector, the projector will prioritize S-Video signal input and image from the Video input will not be played.

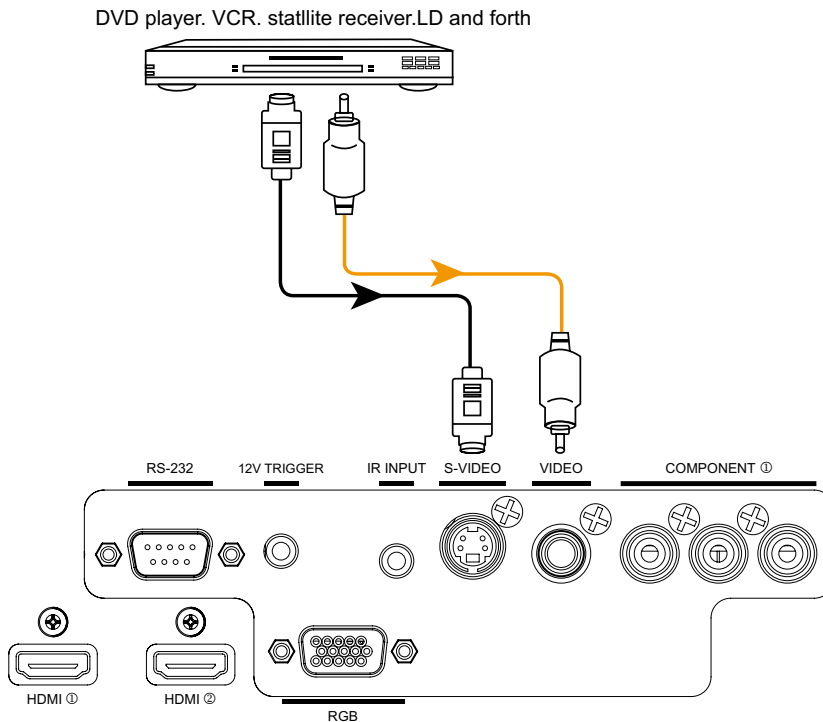

COMPONENT connection

Connect your component video sources to the COMPONENT 1 or RGB inputs as shown.

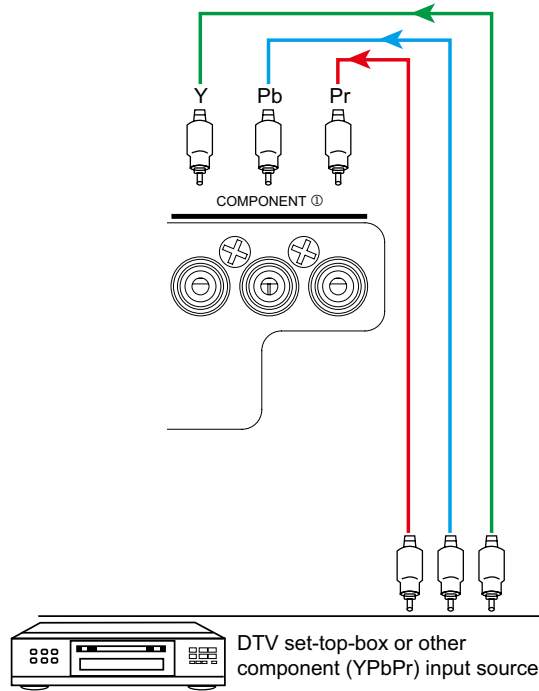

RS-232 Controller Connection

Connect a PC or home theater control/automation system (if present) to the RS-232 port on the H8030. Use a standard, 9-pin serial cable, wired straight-through.

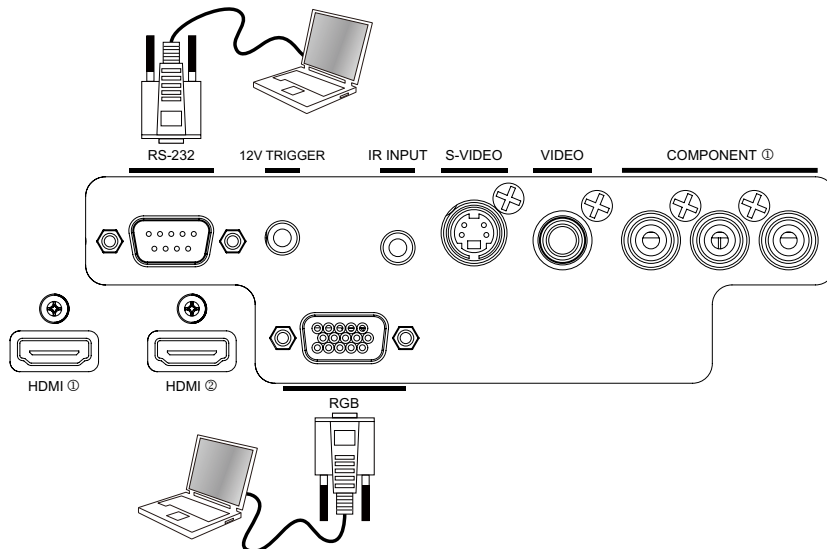

Start using the projector – Adjustments

Connecting to AC Power

Use the supplied AC power cords. Plug the female end of the power cord into the AC receptacle on the rear of the projector (AC 100V ~ 240V); Then, connect the other end to your AC power source.

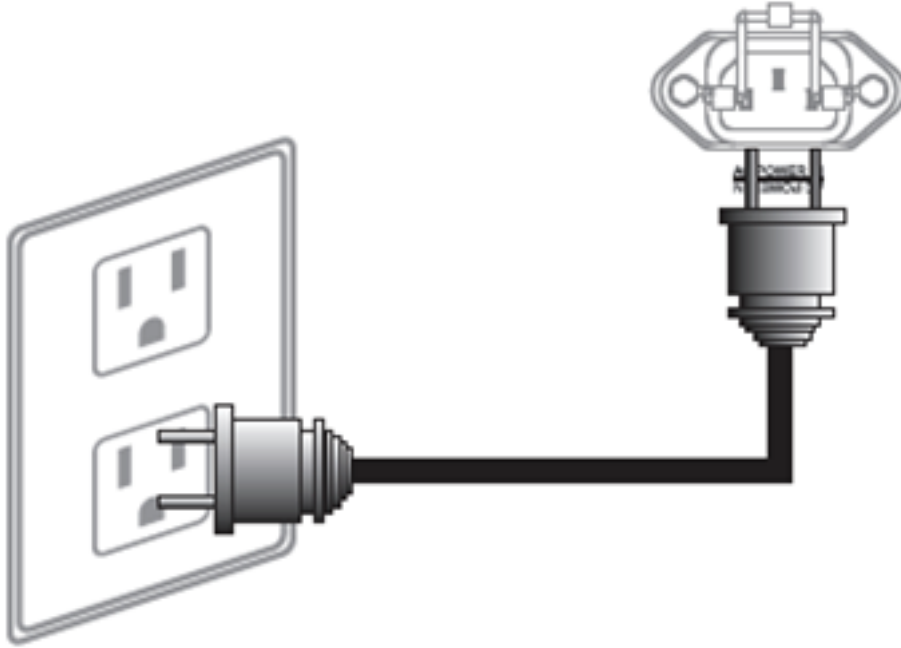

Turning on the Power

Press the ON button on Remote controller or the Power button from the projector's keypad. The power LED indicator flashes green to indicate that it is warming up. When the projector is ready for use, the LED indicator turns off.

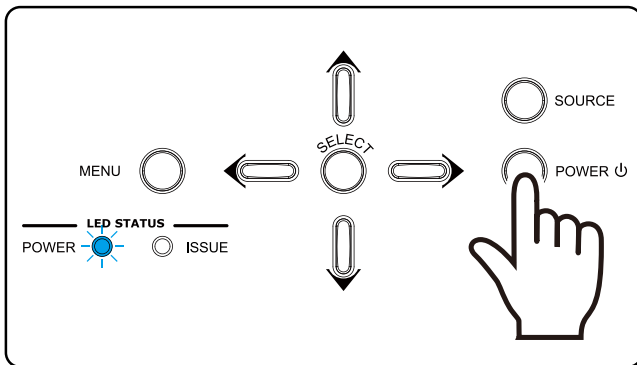

or

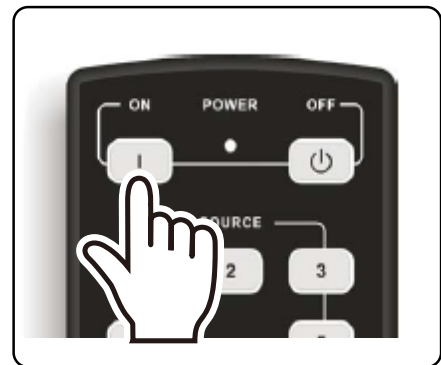

Changing the OSD Language

Press MENU to display the OSD, Press ◀▶ to select LANGUAGE item, then press ◀▶ to select a language that you wanted. Then press ENTER to confirm your selection.

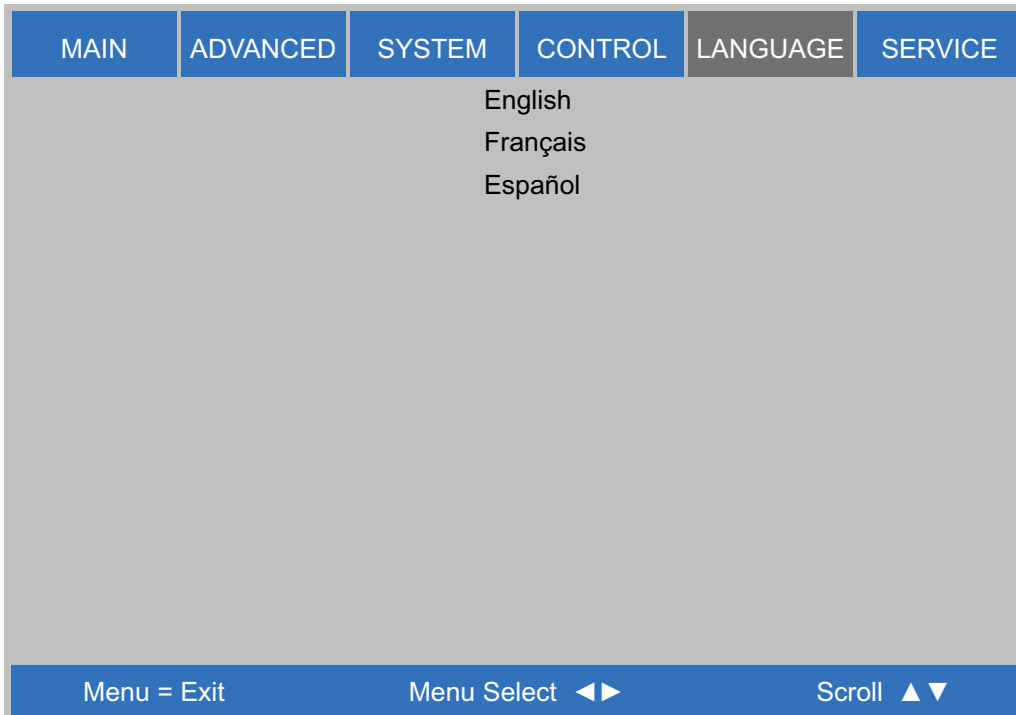

Adjusting the Picture Orientation

The H8030 will automatically invert the image from Floor Front to Ceiling Front if the projector is mounted on the ceiling. If this automatic inversion is not de-sired, please select Ceiling Mode from the OSD Menu -> SYSTEM -> Ceiling Mode -> ON.

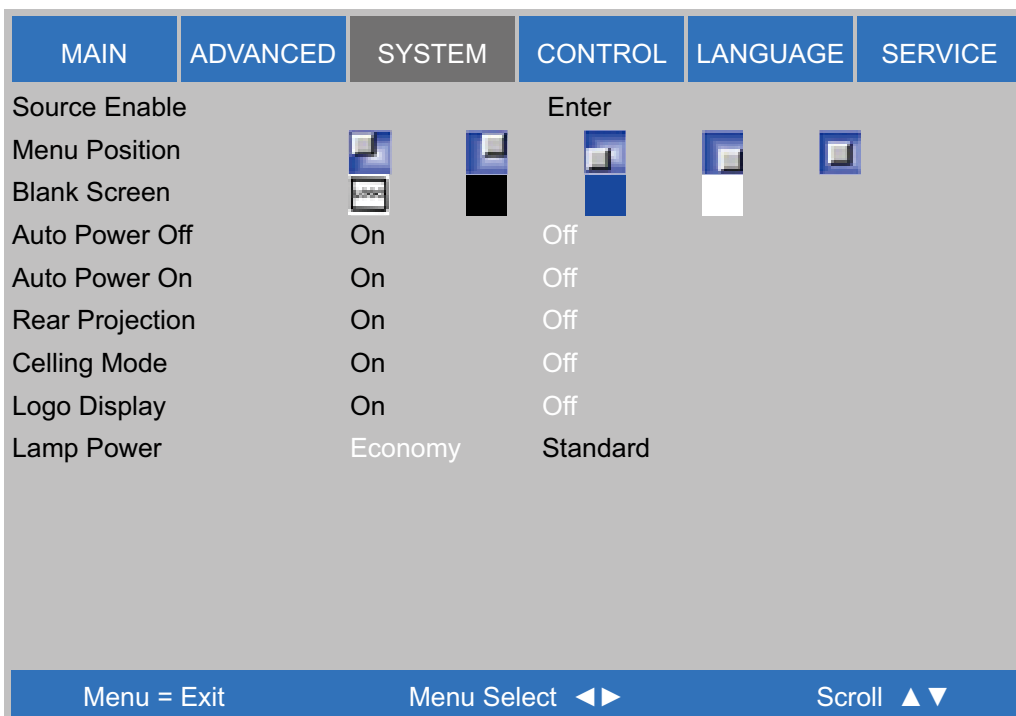

Mechanical Adjustments

The H8030 gives you a great deal of control over the picture size, position and focus. Focus To focus the projected image, grasp the lens by the front ring and rotate it.

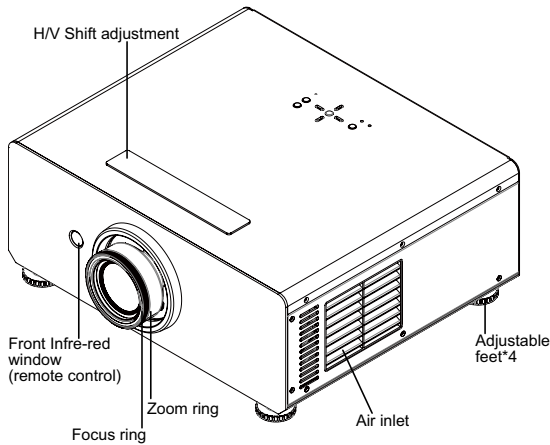

Adjust foot

Rotate the 4 feet on projector for image position.

Note: Ceiling Mode can't adjust this function.

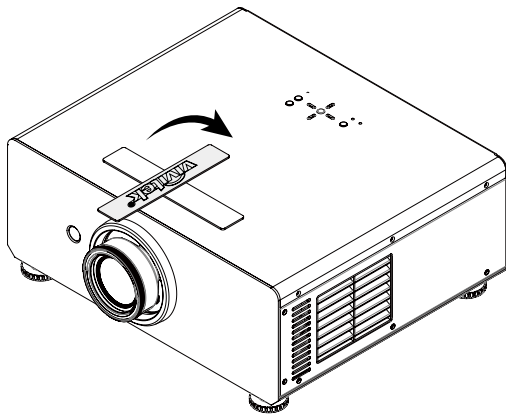

Vertical and Horizontal Lens Shift

To shift the projected image

1. Lift the logo plate upward and turn to expose the adjustment access slots
2. Use the provided hex wrench and insert it into the slot at the top of the projector (directly above the lens). Then, turn the wrench as shown to shift the lens in the desired direction.

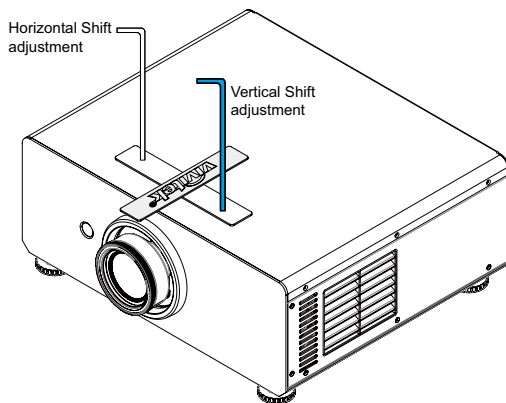

Refer to Page 17 ---

Vertical Lens Shift & Horizontal Lens Shift

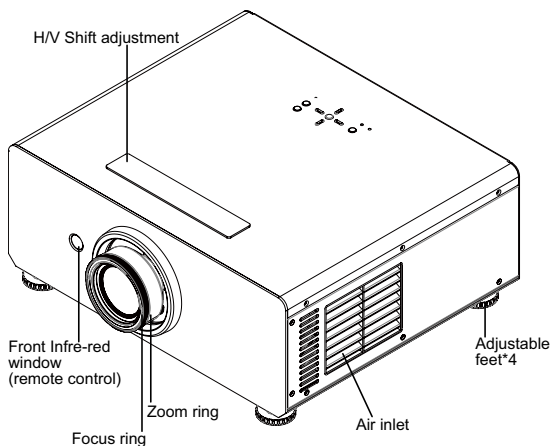

Zoom

To make the picture smaller (zoom out) or larger (zoom in). Rotate the zoom ring in the appropriate direction.

Focus

To make the picture clear or Fuzzy. Rotate the Focus ring appropriate direction.

Operation

Selecting an Input Source

H8030 will remember the last selected input source.

Use these buttons on the remote control to select an input source directly. The default assignments are: 1 = HDMI 1, 2 = HDMI 2, 3 = Component 1, 4 = S-Video, 5 = Video. You can assign each of these five buttons to any input.

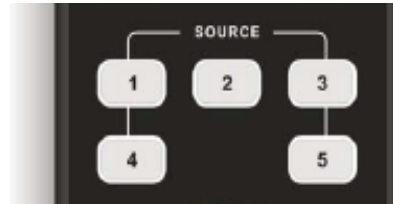

For more information, refer to Page 36 ---
1 Key / 2 Key / 3 Key / 4 Key / 5 Key

Selecting an Aspect Ratio

Press the aspect ratio button to select the appropriate aspect ratio for the type of program material being viewed.



Selecting Video Memory

Press A, B or C to recall settings from a memory preset. Then, press ENTER to confirm your selection. Or, to cancel the operation, press to select Cancel and press ENTER.

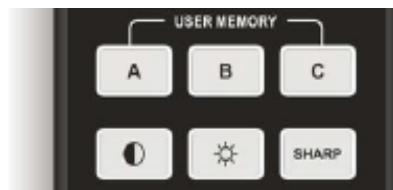

Using the On-Screen Menus (OSD)

1. Press the MENU button on the remote control or system keypad to display the Main Menu.
2. There are six menus. Press ◀ or ▶ to select a sub-menu.
3. Press ▲ or ▼ to select a sub-menu item.
4. For each sub-menu item, the currently-selected value is highlighted. Press ▲ or ▼ to choose a setting for that item, and press ENTER on the remote controller or SELECT on the keypad to adjust the value of that item.
5. Press MENU to return to the previous menu.
6. From the Main Menu, press MENU to turn off the OSD menu.

The H8030 menus are arranged hierarchically, as shown in next page. Depending on the selected input source and signal characteristics, some menu options may not be available.

Start using the projector - OSD Introduction

OSD Menu Tree

The H8030 menus are arranged hierarchically, as shown from below. Depending on the selected input source and signal characteristics, some menu options may not be available.

MAIN	Aspect Ratio	16:9, Letterbox 4:3, 4:3 Narrow, Native	
	Presets	Recall Presets Save Presets	
	Brightness	0....100...200	
	Contrast		
	Saturation		
	Hue		
	Sharpness		
	Noise Reduction		
	Overscan	Off, Crop, Zoom	
	Input Select	HDMI1, HDMI2, RGB, Comp1, Video, S-Video	
Resync	(press Enter to execute)		
ADVANCED	Color Space	Auto, YPbPr, YCbCr, RGB-PC, RGB-Video	
	Video Standard	Auto, NTSC, PAL, SECAM	
	Gamma	CRT, Film, Video, BRIGHT, Graphics	
	Color Temperature	5500K, 6500K, 7500K, 9300K	
	Color Gamut	Auto, REC709, SMPTE-C, EBU, Native	
	Brilliant Color	On, Off	
	Adaptive Contrast	On, Off	
	RGB Adjust	Red offset	
		Green offset	
		Blue offset	
		Red Gain	
		Green Gain	
		Blue Gain	
	Fine Sync	V Position	
		H Position	
Phase			
Tracking			
Sync Level			

SYSTEM	Source Enable	HDMI1, HDMI2, RGB, COMP1, VIDEO, S-VIDEO
	Menu Position	Top Left, Top Right, Bottom Left, Bottom Right, Center
	Blank Screen	Logo, Black, Blue, White
	Auto Power Off	On, Off
	Auto Power On	
	Rear Projection	
	Ceiling Mode	
	Logo Display	
	Lamp Power	Economy, Standard
	CONTROL	1 Key
2 Key		
3 Key		
4 Key		
5 Key		
Trigger-1	Screen, 16:9, Letterbox, 4:3, 4:3 Narrow, RS232	
Auto Source	On, Off	
LANGUAGE	English, Français, Español	
SERVICE	Model Name	(read-only)
	Serial Number	
	Software Version	
	Active Source	
	Pixel Clock	
	Signal Format	
	H/V Refresh Rate	
	Lamp Hours	
	Factory Reset	Reset Everything? (Yes or No)
	Blue Only	On, Off
Test Patterns		
Altitude	Low, High	

OSD Introduction – MAIN

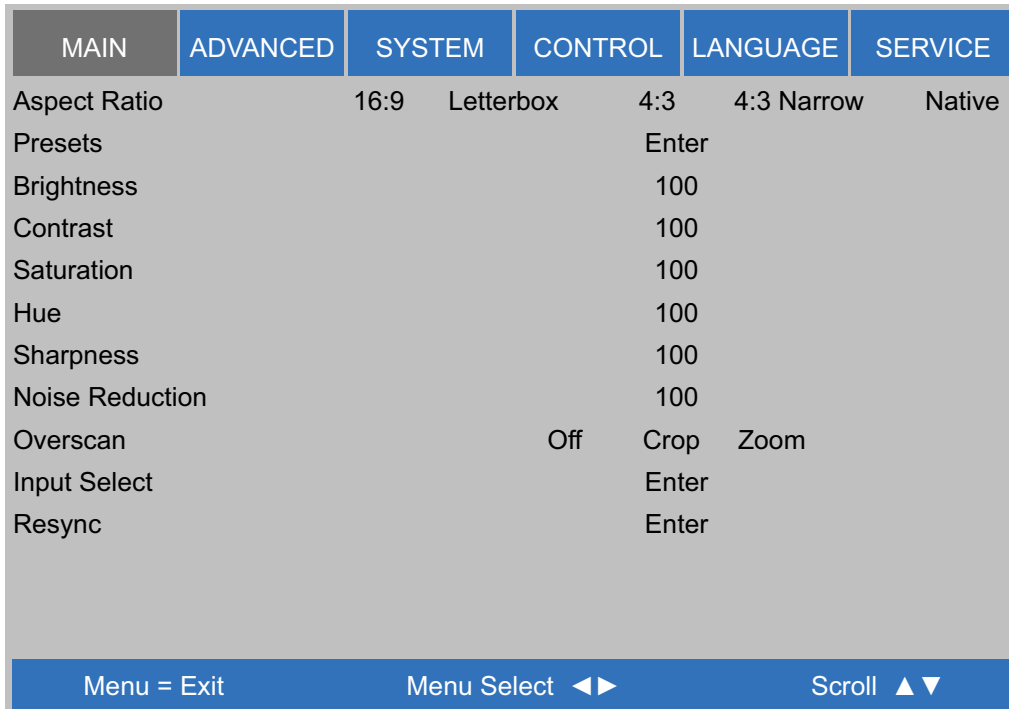

Aspect Ratio: To change the aspect ratio (size and shape) of the projected image, press ▲ or ▼ to highlight Aspect Ratio. Use the ◀ or ▶ buttons to select the appropriate aspect ratio for your screen size, then press **ENTER**.

Original 16:9	Aspect Ratio	Geometry of projected Image
	16:9	
	Letterbox	
	4:3	
	4:3 Narrow	
	Native	

Preset: Select Presets from the Main menu, then press ENTER to recall image quality settings previously saved, or to save changed settings in any of four memory locations.

- **Recall Presets:** Select Recall Presets from the Memory menu to recall saved image quality settings. Unless you select Default (see below), this control affects all sources, not just the active source.
- Custom Memory A, Custom Memory B, Custom Memory C, Custom Memory D, contain the factory default settings when the projector is initially turned on.
- Choose Default to restore the factory-default settings for the active source only. The other sources are unaffected.
- **Save Presets:** Select Save Presets from the Memory menu to save any image-related settings you have changed to Custom Memory A, Custom Memory B, Custom Memory C, and Custom Memory D,

The following items are saved (for all sources, not just the active source):

- Brightness / Contrast
- Color / Color Tint
- Sharpness (all settings in sub-menu)
- Noise Reduction (all settings in sub-menu)
- Color Space
- Video Standard
- Gamma
- Color Temperature
- Color Gamut
- Brilliant Color
- Adaptive Contrast
- RGB Adjust (all settings in sub-menu)
- Lamp Power

Brightness: On your external test pattern source, select a PLUGE pattern. (PLUGE is an acronym for “Picture Line-Up Generation Equipment.”)

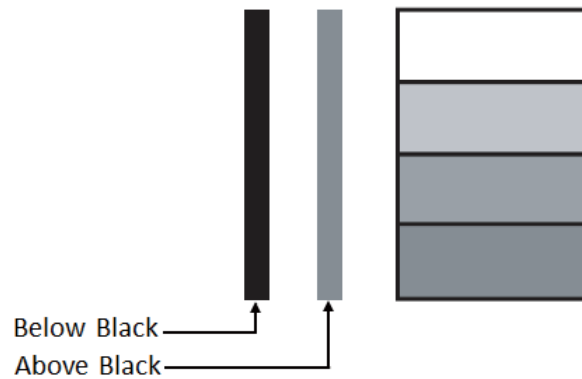

Typical PLUGE Pattern for Adjusting Brightness

PLUGE patterns vary but generally consist of some combination of black, white and gray areas against a background. The example above includes two vertical bars and four shaded boxes.

Select Brightness from the Image menu. Use the ◀▶ buttons to adjust the level so that: The darkest black bars disappear into the background.



- *The dark gray areas are barely visible.*
- *The lighter gray areas are clearly visible.*
- *The white areas are a comfortable level of true white.*
- *The image contains only black, gray and white (no color).*

Contrast: On your external test pattern source, select a stepped, gray-bar pattern like the one shown.



Typical Gray Bar Pattern for Adjusting Contrast

Select Contrast from the IMAGE menu. Use the ◀▶ buttons to adjust the contrast up until the top two bars become almost the same brightness, then down just until the brightness change between these bars is consistent with the other bars.



Note: *Brightness and Contrast controls are interactive. A change to one may require a subtle change to the*

Saturation (Color): Available only for Standard Definition (SD) signals (480i, 576i) in Video, S-Video, and Component inputs.

To adjust the overall color intensity, select Color from the Main menu. Decrease this setting if colors are overly saturated; increase it if colors appear muted.

Hue (Tint): Available only for Standard Definition (SD) signals (480i, 576i) in Video, S-Video, and Component inputs

Hue “Tint” is the ratio of red to green in the color portion of the image. To adjust the tint, select Color Tint from the Main menu. Decrease this setting to shift the hue toward red; increase it to shift the hue toward green.

Note: Like the Brightness and Contrast controls, the color and tint controls are interactive. A change to one may require a subtle change to the other in order to achieve the optimum setting.

Sharpness: The adjustment of sharpness primarily changes the value of high frequency detail. To adjust, select Sharpness from the Main menu and press Enter. Use ◀ ▶ to adjust it.

On your external test pattern source, select a similar pattern as below and adjust as needed. Look for white edges around the transitions from black to gray and differently-sized lines in the “sweep” patterns at the top and bottom. Lower the sharpness setting to eliminate them.

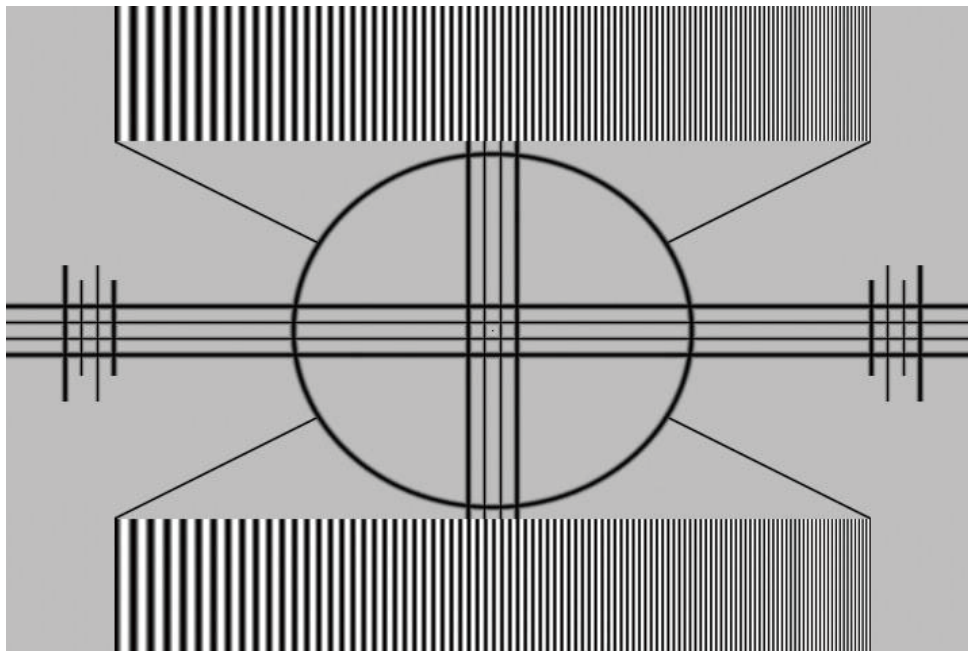

Typical Test Pattern for Adjusting Sharpness

Noise Reduction: Use ◀ ▶ to adjust the noise of the projected image. This function is suitable for the elimination of image noise from interlaced SD input. Keep in mind reducing image noise will lower the value of high frequencies may also soften the image.

Overscan: Some television programs are produced based on the assumption that older television sets may not display the outer edges of the broadcast picture area. Overscan effectively hides these inactive, outer edges of the image. Choose one of the following:

- Off: This setting leaves the image as-is.
- Crop: This setting adds a mask all around edges of the source active image equal to 2.5%.
- Zoom: This setting adds a factor to the scaling of the source active image so that the vertical and horizontal resolutions are 105% of the size determined by the aspect ratio function. Anything outside of the original image area is removed.

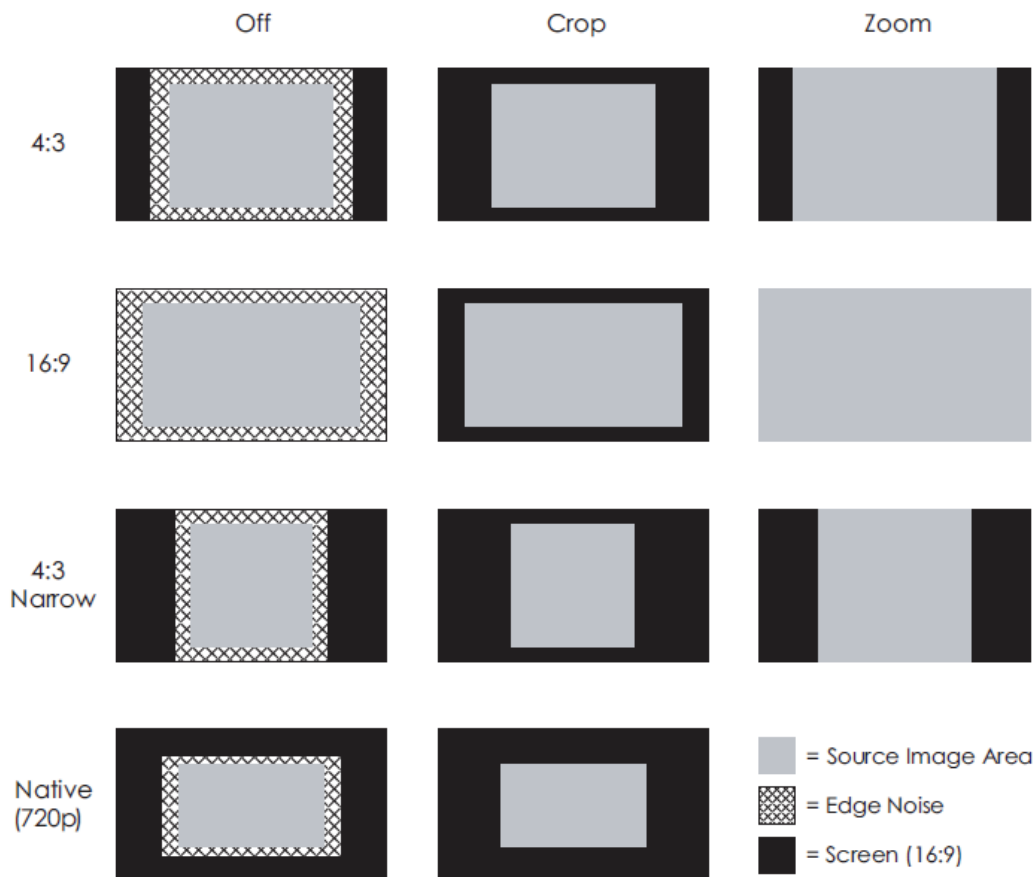

Input Select: This function is same as the hotkey which on Remote controller. You can use Remote controller or this function to select the correct input source

To select a video source, from Main Menu use ▲ or ▼ to highlight Input Select, then press Enter, use ▲ or ▼ to highlight the desired source, then press ENTER.

Resync: If the projected image becomes unstable or degraded, press ▲ or ▼ to highlight Resync, then press ENTER. It also changes any Fine Sync setting for this timing to the default setting.

OSD Introduction – ADVANCE

MAIN	ADVANCED	SYSTEM	CONTROL	LANGUAGE	SERVICE
Color Space	Auto	YPbPr	YCbCr	RGB-PC	RGB-Video
Video Standard	Auto	NTSC	PAL	SECAM	
Gamma	CRT	Film	Video	BRIGHT	Graphics
Color Temperature	5500K	6500K	7500K	9300K	
Color Gamut	Auto	REC709	SMPTE-C	EBU	Native
BrilliantColor	On		Off		
Adaptive Contrast	On		Off		
RGB Adjust			Enter		
Fine Sync			Enter		

Menu = Exit Menu Select ◀▶ Scroll ▲▼

Color Space: Select Color Space from the Advanced menu to choose the color space of the source signal for HDMI, RGB, and component connections.

- The default setting, Auto, functions as follows:
- **HDMI:** If the Auxiliary Video Information (AVI) infoframe contains color space and/or range data, the H8030 uses that information. Otherwise, for RGB sources, the H8030 uses the RGB-Video color space. For component SDTV and EDTV resolutions, REC601 is used. For other component video resolutions, REC709 is used.
- **RGB:** If Hsync or Vsync signals are present, the H8030 uses the RGB-PC color space. Otherwise, REC601 is used for SDTV and EDTV sources, and REC709 for all other sources.
- **Component:** For SDTV and EDTV resolutions, the H8030 uses the REC601 color space. For all other resolutions REC709 is used.

In most cases, the Auto setting determines the correct color space to use. If it does not, you can force the H8030 to use a specific color space. Choose one of the following:

- **REC709** sets the color space matrix to that defined in ITU-R BT.709.
- **REC601** sets the color space matrix to that defined in ITU-R BT.601.
- **RGB-PC** uses RGB color space and sets black at 0,0,0 RGB and white at 255,255,255 RGB.
- **RGB-Video** uses RGB color space and sets black at 16,16,16 RGB and white at 235,235,235.

Video Standard: Select Video Standard from the Advanced menu to specify the color system for composite video or S-Video input signals.

Different countries use different formats for video signals. Select the appropriate Video Standard for your region:

- **Auto:** The color systems are automatically identified and the format is set accordingly.
- **NTSC:** (National Television Systems Committee): This is the standard format used

mainly in the United States and Japan.

- PAL: (Phase Alternation by Line): This is the standard used in Europe, Australia and many other parts of the world, typically with a 50Hz frame rate.
- SECAM (Sequential Color With Memory): This is a standard format used mainly in France and Russia.
- NTSC: This is the standard format used mainly in the United States and Japan.

Gamma: Select Gamma from the Advanced menu to choose a DLP de-gamma curve. Used correctly, the Gamma control can improve contrast while maintaining good details for blacks and whites.

If excess ambient light washes out the image and it becomes difficult or impossible to see details in dark areas, lower the gamma setting to compensate. This improves contrast while maintaining good details for blacks. Conversely, if the image is washed out and unnatural, with excessive detail in black areas, increase the setting.

- CRT sets the gamma to 2.5.
- Film sets the gamma to 2.2.
- Video is similar to Film gamma but differs in dark areas of the image to correspond to the function that video cameras use to create images.
- Bright sets the gamma to 2.0.
- Graphics should only be used for computer presentations that require increased brightness at the cost of grayscale accuracy.

Color temperature: Color temperature defines the “color of gray;” that is, adjusts the 75% white point to various color points.

To choose a color temperature setting, select Color Temperature from the Advanced menu. Then, press ◀ ▶ to select 5500K, 6500K, 7500K, 9300K. The default setting, 6500K, is appropriate for most situations. Higher settings produce a “bluer picture; lower ones impart a reddish hue to the image.

Gamut: Select Color Gamut from the Advanced menu to select a color gamut (range) that may be different from the default color gamut.

Each setting defines the precise hue of each primary (red, green and blue) and secondary (yellow, cyan and magenta) color component used to generate the millions of colors produced in displays. Changing either or both of these numbers changes the hue of the color and relocates the “triangle” for possible colors. For example, changing the x/y coordinates for red moves the color closer to either orange or violet, which in turn affects all displayed colors having a red component.

- Auto automatically chooses the appropriate color gamut:
 - SMPTE C for NTSC, 480i and 480p sources.
 - EBU for PAL, SECAM, 576i and 576p sources.
 - REC709 for all other sources.
- REC709 chooses the REC709 color gamut.
- SMPTE-C to choose the SMPTE-C color gamut.
- EBU to choose the EBU color gamut.

- **NATIVE** It displays the fully saturated LED color gamut and also enable HSG feature for custom color gamut settings.

Brilliant Color: Enable (On) or disable (Off), which improves brightness in grays and secondary colors by allowing simultaneous display of multiple colors from the LED light sources.

Adaptive Contrast: Adaptive Contrast enhancement expands the light and dark portions of an output image according to the mean luminance of the input image.

RGB Adjust: Also known as White Balance Adjust. This feature is to remove any trace of color from the white areas of the projected image and to achieve to the desired white temperature, choose RGB Adjust from the Advanced menu and press ENTER. This displays the RGB Adjust sub-menu.

- **Gain** Use the Gain controls to correct color imbalances in the bright areas of the image. A good way to do this is to use a test pattern consisting mostly of solid white areas, such as an 80 IRE “window” pattern. If the white areas contain traces of red, green or blue, decrease the Gain for that color.
- **Offset** Use the Offset controls in the RGB Adjust sub-menu to correct color imbalances in the dark areas of the image. A good way to do this is to use a test pattern consisting mostly of dark gray areas, such as a 30 IRE “window” pattern. If the gray areas contain traces of red, green or blue, decrease the Offset for that color.

***Note:** The Gain controls increase or decrease the full-scale input range; the Offset controls shift the entire range, resulting in a change in brightness. Generally, higher Gain settings reduce the image contrast; higher Offset settings reduce the image brightness.*

Fine Sync: To fine-tune the position and other image attributes.

- **V Position:** Select this function to adjust the vertical position of the image within the designated image area, up to 25% up or down of the image height.
- **H Position:** Select this function to adjust the horizontal position of the image within the designated image area, up to 25% right or left of the image width.
- **Phase (for RGB or Component sources):** This control adjusts the phase of the pixel sampling clock relative to the incoming signal. Adjust the phase when an RGB or Component image still shows shimmer or “noise” after Tracking has been optimized.
- **Note:** Adjust the Phase after adjusting Tracking (see below). If some shimmer from a video or HDTV source persists, use the Noise Reduction controls to remove high-frequency noise from the signal.
- **Tracking (for RGB or Component sources):** Tracking determines the frequency of the pixel sampling clock, indicated by the number of incoming pixels per line, so that all pixels generated by a particular source are sampled. Steady flickering or several soft vertical stripes or bands across the entire image indicates poor pixel tracking. Proper pixel tracking helps ensure that the image quality is consistent across the screen, that aspect ratio is maintained and that pixel phase can be optimized.

- **Sync Level (for Component sources only):** Select Sync Level to adjust the voltage level of the H8030 Sync signal detection circuitry. Sync Level adjustment is occasionally necessary when a DVD player or HDTV source signal drops “below black” (for example, during scenes with explosions or when subtitles are present) and causes the projector to temporarily lose sync. If the Sync Level from the source is persistently too low, the projector won’t sync with the source at all. The range is from 50 to 256 millivolts (mV) inclusive. The default setting is 240 mV and should rarely require adjustment.

OSD Introduction – SYSTEM

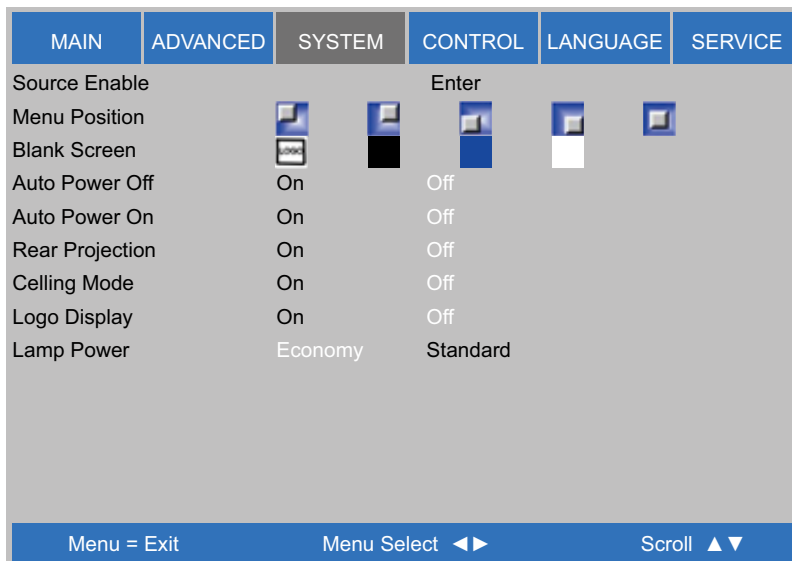

Source Enable: To enable or disable selection of a source, choose Source Enable from the System menu and press ENTER. This displays the Source Enable sub-menu

Menu Position: Select Menu Position from the System menu to change the OSD menu position.

Blank Screen: Select Blank Screen from the System menu to choose the color of the blank screen that appears when no source signal is present. The options are Logo, Black, Blue and White. The default is Black.

Auto Power Off: Set Auto Power Off to On to have the H8030 turn itself off after 20 minutes of inactivity (no source signal present).

Auto Power On: The default setting is Off. If you set it to ON, the projector will automatically start up when it is connected to AC power. If you plug the projector’s power cord into an AC socket with a switch, you can use this function to start up the projector using the socket’s switch instead of the remote. If you do not need this function, please set it to Off.

Rear Projection: This control reverses all images and menus, and is necessary when the projector is used in rear-projection applications. The default is Off. *Refer to Page 15 --- Modes of installation*

Ceiling Mode: This control flips the image so the projector can be used in ceiling mounted installations. The default setting, Auto, automatically determines the orientation using an internal sensor. *Refer to Page 15 --- Modes of installation*

Logo Display: This feature enable and disable Vivitek brand logo during projector warming up stage.

Lamp Power: This control ECO will automatically set the lamp power to 80%. Standard will set the power to 100%. Standard Projection is carried out using the normal lamp power to obtain the brightest projection display. ECO Projection is carried out in the energy saving mode to ensure the longest service life of the lamp.

OSD Introduction - CONTROL

Select Control from the Main Menu to set various options related to control of the projector.

MAIN	ADVANCED	SYSTEM	CONTROL	LANGUAGE	SERVICE
1 Key			Enter		
2 Key			Enter		
3 Key			Enter		
4 Key			Enter		
5 Key			Enter		
Trigger-1		Screen 16:9	Letterbox 4:3	4:3 Narrow	RS232
Auto Source		On	Off		

Menu = Exit Menu Select ◀▶ Scroll ▲▼

1 Key / 2 Key / 3 Key / 4 Key / 5 Key: These menu items assign the function of the keys numbered 1 through 5 on the remote.

There are seven sources corresponding to the eight connections to the projector. When you assign a source to a numbered key, the projector immediately goes to that source when the key assigned to it is pressed.

If the chosen source is disabled via the Source Enable menu, this setting has no effect.

Trigger 1: Select Trigger 1 from the Control menu to specify when the Trigger 1 port outputs 12 volts. There is a three-second delay before activation to prevent operation while selecting an aspect ratio.

- Screen: The port to output 12 volts whenever the lamp is on.
- 16:9: Causes the port to output 12 volts whenever the 16:9 aspect ratio is chosen.
- Letterbox: Causes the port to output 12 volts whenever the Letterbox aspect ratio is chosen.
- 4:3: Causes the port to output 12 volts whenever the 4:3 aspect ratio is chosen.
- 4:3 Narrow: Causes the port to output 12 volts whenever the 4:3 Narrow aspect ratio is chosen.
- RS232: Causes the port to output 12 volts when an RS232 screen trigger 1 “on” command is received and stop when trigger 1 “off” command is received. The 12 volt output also stops when the projector is turned off.

Auto Source: Default setting is “Off”. By enabling this function, the projector will automatically determine the source of input every time it is turned on so that the user will not have to make the selection on the OSD Menu. Setting the function off will require the

user to specify source of image input on the OSD Menu in order for the projector to display the intended image.

OSD Introduction – LANGUAGE

Choose the OSD display language that you familiar. English, French or Spanish.

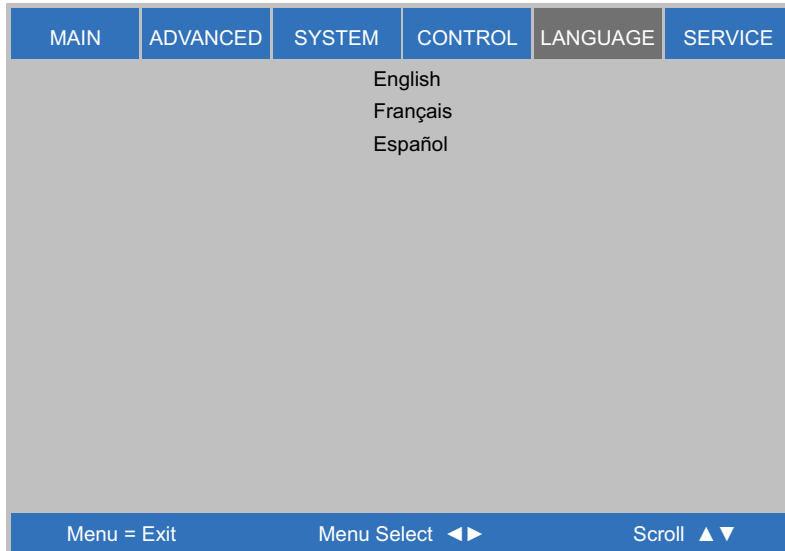

OSD Introduction – SERVICE

The functions covered in this unit relate to the display of some basic information about the projector.

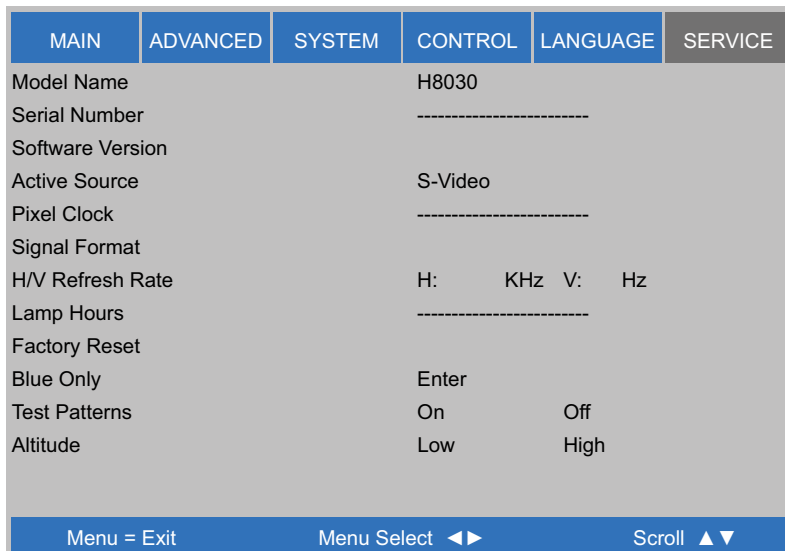

- **Model:** The designated model number of the projector.
- **Serial Number:** The designated serial number of the projector.
- **Software Version:** The version of software installed on the projector.
- **Active Source:** Displays the current detected sources.
- **Pixel Clock:** Displays the pixel clock of the current input signal.
- **Signal Format:** Displays the format of the current input signal.
- **H/V Refresh Rate:** Displays the horizontal and vertical refresh rates for the current

image.

- **Lamp Hours:** Display the Lamp usage time.
- **Factory Reset:** Use this function to restore the configurations in the OSD Menu back to factory default. Note that this function will not apply to items including no signal, network, Projector control, startup Logo, language, High Altitude mode.
- **Blue Only:** Enabling this option will make the projector display only blue color to facilitate the process of image inspection for the service personnel. For detailed instructions on how to use this function, consult a qualified service personnel.
- **Test Patterns:** The H8030 has numerous internal test patterns that are useful to technicians for advanced calibration, measurement and fault isolation purposes. To access them, select Test Patterns from the Service menu and set it to On.

Press ◀ ▶ on the remote control unit or built-in keypad to cycle through the test

The available test patterns are:

- White
 - Black
 - Red
 - Green
 - Blue
 - Cyan
 - Magenta
 - Yellow
 - ANSI Checkerboard
 - Horizontal Gray Ramp
 - Focus Grid
 - Off
-
- **Altitude:** Use this function to control the projector's cooling fan. You can set it to Low or High. The default setting is Off.

In most cases, the default setting (Low) will maintain the correct operating temperature. If in certain high-altitude operating environments, you may need to change this setting to High.

Change Lamp

The lifecycle of ordinary projection lamp typically lasts for 2000 hours (Normal mode), 4000 hours (Economy mode) before requiring replacement (different lamp configurations will affect lamp life). From the OSD Menu to check how long a lamp has been used. You should also replace the lamp when the projected image gets noticeably darker. Contact your local dealer to purchase new certified lamps for your projector.

To replace the projector lamp

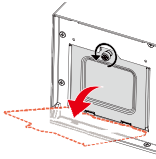
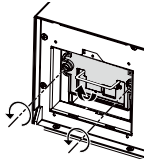
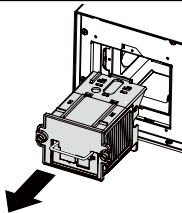
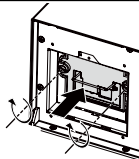
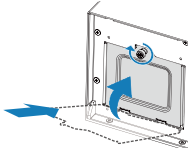
<p>1. Turn off the projector and unplug the power cord. Let the projector cool for approximately 60 minutes before removing the lamp module for replacement.</p> <p><i>When you turn off the projector, the lamp inside the projector will still be very hot (approximately 200 ~ 300°C). If you attempt to replace the lamp without allowing the projector to cool, you could risk scalding yourself. This is why you should wait for no less than 60 minutes for the lamp to cool down in order to perform the replacement safely.</i></p>	
<p>2. Loosen the lamp cover.</p> 	<p>3. Use a screw driver to loosen the screws as shown in the illustration.</p> 
<p>4. Grasp the metal rod on the lamp cover and pull the lamp out.</p> 	<p>5. Insert the new lamp in the direction shown in the illustration into the lamp assembly; tighten the two screws using a screw driver and make sure the lamp is firmly secured to prevent the lamp from shaking or poor contact.</p> 
<p>6. Replace the lamp cover and firmly secure the two screws on the lamp cover.</p> 	

Maintenance and Troubleshooting

Table below provides some general guidelines for troubleshooting problems you may encounter with the H8030. If the suggested solutions fail to resolve the problem or if you encounter an issue not described here, please contact Vivitek Technical.

Troubleshooting Chart

Symptom	Possible Cause (s)	Solution
The projector does not turn on.	<ul style="list-style-type: none"> The H8030 is not plugged in or the AC outlet is not active. 	<ul style="list-style-type: none"> Ensure that the H8030 is plugged in and that the AC outlet is active.
The remote control does not work correctly.	<ul style="list-style-type: none"> The batteries have run out. IR code set mismatch between remote control unit and projector. 	<ul style="list-style-type: none"> Replace the batteries Press and hold the LIGHT and ENTER remote control buttons simultaneously until the remote control back-lighting "blinks" (approximately five seconds). Then, try again.
The projector is on and OSD menus appear, but there is no video image on-screen.	<ul style="list-style-type: none"> Incorrect source selection. Source component is not turned on. Source component is connected incorrectly or not at all. 	<ul style="list-style-type: none"> Select the correct source. Turn on the source. Check cable connection from source component to projector.
A projected image from a DVD is split or otherwise scrambled.	<ul style="list-style-type: none"> DVD player is connected to the Component input and set to progressive scan mode. 	<ul style="list-style-type: none"> Turn off progressive scan on the DVD player.
Image is blurred.	<ul style="list-style-type: none"> The lens is not correctly focused. 	<ul style="list-style-type: none"> Adjust the focus with the remote control.
Image is too bright and/or lacks definition in the bright areas of the image.	<ul style="list-style-type: none"> Contrast is set too high. 	<ul style="list-style-type: none"> Lower the contrast setting.
Image appears "washed out" and /or dark areas appear too bright.	<ul style="list-style-type: none"> Brightness is set too high. 	<ul style="list-style-type: none"> Lower the brightness setting.
Colors in the image are swapped; for example, reds appear blue or vice versa.	<ul style="list-style-type: none"> The Red/Pr, Green/Y or Blue/Pb outputs from the source are connected to the wrong inputs on the H8030. 	<ul style="list-style-type: none"> Ensure that the source outputs are connected to the correct H8030 input.
RGB-HD images appear "noisy"	<ul style="list-style-type: none"> Tracking and Phase settings need adjustment. 	<ul style="list-style-type: none"> Manually adjust Tracking and Phase settings.
LED is flashing red.	<ul style="list-style-type: none"> H8030 internal temperature is too high (Note). 	<ul style="list-style-type: none"> Power off the H8030 and allow it to cool down. Ensure that the intake and exhaust vents are not blocked. Turn the projector back on. If the problem persists, please contact Vivitek Technical Support for assistance.
LED lights solid red.	<ul style="list-style-type: none"> Fans are not working properly or power-on self-test has failed (Note). 	<ul style="list-style-type: none"> Power off the H8030 and allow it to cool down. Turn the projector back on. If the problem persists, please contact Vivitek Technical Support for assistance.
<ul style="list-style-type: none"> Note: You can obtain more detailed information about the same cause of the error condition using TRS-232 commands 		

Serial Communications

RS-232 Connection and Port Configuration

To interface the H8030 with a home theater automation/control system or a PC running terminal emulation software:

1. Connect it to your control system or PC.
2. Start a terminal session on your PC using a terminal-emulation program, such as HyperTerminal.
3. Configure the RS-232 controller or PC serial port as follows: 38400 bps, no parity, 8 data bits, 1 stop bit and no flow control.
4. Type ky or op followed by a command from among those listed and press <Enter>. For example, to change the aspect ratio to Letterbox, type op aspect = 1<Enter>.

Serial Command Syntax

Serial commands to the H8030 take the following form:

- Commands are in ASCII format.
- Spaces and tabs can be used to improve readability and are ignored by the projector.
- All commands must end with a carriage return (ASCII hex 0D) to signify that the projector can now read and execute the command.
- Commands are not case-sensitive.

The H8030 supports two types of commands: key commands and operation commands. Key commands mimic pressing a button on the remote control. Operation commands tell the projector exactly what to do.

All commands start with 2 letters:

ky for key commands.

op for operations commands.

Key Commands: The syntax for key commands is simple

ky <keyname>[CR]

Some key command examples:



























ky menu [CR] Bring up or cancel menu display.

The response from the projector for key commands will be the same command in UPPERCASE.

ky menu [CR]

KY MEMU[CR]

Serial Command Key Names

RS232 Keyname	Remote Button	Description
power.on		Turn power on.
power.off		Turn power off.
menu		Bring up or cancel menu display.
enter		Keypad enter.
down		Keypad down arrow.
up		Keypad up arrow.
left		Keypad left arrow.
right		Keypad right arrow.
bright		Bring up or cancel brightness slider
contrast		Bring up or cancel contrast slider
sharp		Bring up or cancel sharpness slider
nr		Bring up or cancel noise reduction slider
gam.sw		Switch to the next gamma
src.1		Switch the active source to source 1.
src.2		Switch the active source to source 2.
src.3		Switch the active source to source 3.
src.4		Switch the active source to source 4.
src.5		Switch the active source to source 5.
osc.sw		Switch to the next Overscan mode
mem.1		Recall user memory associated with the Preset A key
mem.2		Recall user memory associated with the Preset B key
mem.3		Recall user memory associated with the Preset C key
asp.sw		Switch to the next aspect ratio.
bcolor.sw		Toggles between BrilliantColor On and BrilliantColor Off
ctemp.sw		Change to next Color Temperature
pattern.sw		Activate Test Patterns

Operations Commands: Operations commands allow more flexible and direct control of the projector. The syntax for operations commands is as follows:

op <operation> <command>[CR]

(Precede <operation> and <command> with a space.)

The command type can be one of 5 functions:

Operation Control Commands		
Function	Command	Action on unit
Set	= <value>	Makes the unit take that value.
Get	?	asks what the current value is.
Increment	+	Add 1 to the current value.
Decrement	-	Subtracts 1 from the current value.
Execute		Performs and action as a reset.

- Below are lists the valid operations commands. For all but Execute functions, the response from the projector is the command and “= <value>” where <value> is the current value or “NA” if the value is not available. For Execute functions the response is the same command. All responses are in UPPERCASE.

Some operations command samples:

Input	Response
op bright ? [CR]	OP BRIGHT = 100
op bright + [CR]	OP BRIGHT = 101
op bright = 127 [CR]	OP BRIGHT = 127
op bright - [CR]	OP BRIGHT = 126
op sharp. simple = 50 [CR]	Unknown Command
op sharp.simple ? [CR]	Unknown Command

Serial Operation Commands (continued)

The last two commands show what happens when a control is grayed out. In this case, the sharpness mode was set to advanced (value = 1) and then the simple sharpness slider was attempted to be adjusted and queried. The response was “NA” or not available.

Serial Command	Operand	Value	Notes
aspect	= ?	0 = 16:9 1 = Letterbox 2 = 4:3 3 = Theaterscope 4 = Native	
recall.mem	= ?	0 = Preset A 1 = Preset B 2 = Preset C 3 = Preset D 4 = Default	
save.mem	=	0 = Preset A 1 = Preset B 2 = Preset C 3 = Preset D	
bright	= ? + -	0 - 200	
contrast	= ? + -	0 - 200	
saturat	= ? + -	0 - 200	
tint	= ? + -	0 - 200	
sharp	= ? + -	0 - 200	
nr	= ? + -	0 - 200	
zoom	= ?	0 = Off 1 = Crop 2 = Zoom	
input.sel	= ?	0 = HDMI 1 1 = HDMI 2 2 = RGB 3 = YPrPb 1 4 = S-Video 5 = Video	
auto.img	(execute)		
color.space	= ?	0 = Auto 1 = REC709 2 = REC601 3 = RGB-PC 4 = RGB-Video	

video.stand	= ?	0 = Auto 1 = NTSC 2 = PAL 3 = SECAM	
gamma	= ?	0 = CRT 1 = Film 2 = Video 3 = Bright 4 = Graphics	
color.temp	= ?	0 = 5500K 1 = 6500K 2 = 7500K 3 = 9300K 4 = Native	
color.gamut	= ?	0 = Auto 1 = REC709 2 = SMPTE C 3 = EBU 4 = Native	
bcolor	= ?	0 = Off 1 = Smooth	
dlp.frame	= ?	0 = Auto 2 = 48 Hz 3 = 50 Hz 4 = 60 Hz	
red.offset	= ? + -	0-200	
green.offset	= ? + -	0-200	
blue.offset	= ? + -	0-200	
red.gain	= ? + -	0-200	
green.gain	= ? + -	0-200	
blue.gain	= ? + -	0-200	
v.pos	= ? + -	0-200	
h.pos	= ? + -	0-200	
h.phase	= ? + -	0-200	
tracking	= ? + -	0-200	
sync.level	= ? + -	0-200	
osd.menupos	= ?	0 = Top left 1 = Top right 2 = Bottom left 3 = Bottom right 4 = Center	

blank.screen	= ?	0 = Black 1 = Blue 2 = White 3 = Logo	
auto.poweroff	= ?	0 = Off 1 = On	
auto.poweron	= ?	0 = Off 1 = On	
rear.proj	= ?	0 = Off 1 = On	
ceil.mode	= ?	0 = Off 1 = On 2 = Auto	
startup.logo	= ?	0 = Off 1 = On	
1.key 2.key 3.key 4.key 5.key	= ?	0 = HDMI 1 1 = HDMI 2 2 = RGB 3 = YPrPb 1 4 = S-video 5 = Video	
auto.source	= ?	0 = Off 1 = On	
M1. key	= ?	0 = Preset A	Label 'A' on the RC key
M2. key	= ?	0 = Preset B	Label 'B' on the RC key
M3. key	= ?	0 = Preset C	Label 'C' on the RC key
lamp.hours	?	<number>	
model	?	<string>	
ser.number	?	<string>	
soft.version	?	<string>	
act.source	?	0 = HDMI 1 1 = HDMI 2 2 = RGB 3 = YPrPb 1 4 = S-video 5 = Video	
h.refresh	?	<number>	kHz

v.refresh	?	<number>	Hz
pixel.clock	?	<number>	MHz
signal	?	<string>	
total.hours	?	<number>	
environment	?	<string>	Temperatures
fact.reset	(execute)		
lamp.reset	(execute)		
pattern	=	0 = White 1 = Black 2 = Red 3 = Green 4 = Blue 5 = Cyan 6 = Magenta 7 = Yellow 8 = ANSI Checkerboard 9 = Horizontal Gray Ramp 10 = Focus Grid 11 = Off	
altitude	= ?	0 = low 1 = high	
status	?	0 = standby 1 = warm up 2 = imaging 3 = cooling 4 = error	
FVER	?	<string>	
trig.1 trig.2	= ?	0 = Screen 1 = 16:9 2 = Letterbox 3 = 4:3 4 = 4:3 Narrow 5 = RS232 6 = On 7 = Off	IF you want select 6 or 7, please select 5 at first
language	= ?	0 = English 1 = French 2 = Spanish	
lamp.pow	= ?	0 = economy 1 = standard	
adcontrast	= ?	0 = Off 1 = On	

RS-232 Error Codes

If an errcode ? command returns one of the following values, you have encountered a likely system error requiring the attention of a qualified service technician. Try resetting the projector by powering it off, allowing it to cool and powering it on again.

The specific code number identifies the source of the error detected, and is particularly useful in cases where the projector is far away. For example, the code "7" means that Fan 1 has failed.

Error Code	Description
0	Inlet NTC thermal sensor is over temperatuer.
1	Color wheel NTC thermal sensor is over temperature.
2	Lamp 1 over temperature
3	Lamp 2 over temperature
4	Ballast 1 over temperature
5	Ballast 2 over temperature
6	Fans error when system power on.
7	Fan1 locked
8	Fan2 locked
9	Fan3 locked
10	Fan4 locked
11	Fan5 locked
12	Fan6 locked
13	Fan7 locked
14	Fan8 locked
15	DDP3021 communication fail when system power on
16	Lamp ignited fail 3 times when system power on
17	Lamp shut down while system is working
18	Ballast UART communication fail
19	PCF8575 external GPIO communication fail, it can crash system.
20	Lamp door was opened.
21	GENNUM SPI communication fail when system power on.
22	System hardware I2C communication fail, it can crash system.
23	System software I2C communication fail.
24	Temp sensor error.
25	check sum of EEPROM error.
26	check sum of EDID error.
27	Check version of EEPROM fail.
28	Genum Reset.
29	Osd load error.

Specifications

H8030 Specifications

Optics	
Technology	TI DLP 1080p (1920 x 1080) 0.95" DMD
Light Source	UHP Lamp 230W
Projector Lens	Standard Lens throw ratio: 1.85 to 2.4:1 Short Lens throw ratio: 1.56 to 1.86:1 (optional) Long Lens throw ratio: 2.4 to 4.0:1 (optional)
Lens Shift	<ul style="list-style-type: none"> • Vertical \pm 60% • Horizontal \pm 15%
Image width range	8ft to 30ft
Electrical	
I/O - Video Input	<ul style="list-style-type: none"> • DB15 pin RGB • 2 x HDMI • Component 1 - RCA • Composite (RCA) • S-Video
I/O - Power Input	IEC-320-C14receptacle
Projector Control	<ul style="list-style-type: none"> • Hard wired via RS-232 • IR Remote • Keypad control method
Zoom/Focus/Offsets	Manual lens shift, Manual zoom/focus
Projection Modes	Front/ Rear/ Ceiling (Front/Rear)
Power	<ul style="list-style-type: none"> • Input Voltage: 100 ~ 240V • Power Consumption Standard mode: 340 W Standby <1W (Typical).
Safety	UL 60950 -1, RoHS compatible , IEC-60825-1
EMI FCC	FCC Class B
Mechanical	
Weight (without packing)	10.9 Kg (24 lb)
Dimensions	432.4 x 366.8 x 161.5mm
Adjustable feet	2" max travelReliability

H8030 Specifications (continued)

Reliability	
Operating Temperature	<ul style="list-style-type: none"> • 7500 ft.~10000 ft. (2286m ~ 3048m): 50 ~ 95°F (10 ~ 35°C), Humidity: 0% ~ 85% • Under 7,500 ft. (2286m): 50 ~ 104°F (10 ~ 40°C), Humidity: 0% ~ 85%
Storage	-4 ~ 140°F (-20 ~ 60°C), Humidity: 5% ~ 90%
Standard Accessories	
Power Cord	US 110VAC
Remote and Batteries	For set up and use only
HDMI Cable	For set up and use only
User Manual CD	For set up and use only
Warranty Card	
Allen Wrench	For lens shift adjustment

Note: Specifications are subject to change without notice

Dimensions

H8030 dimensions are in millimeter

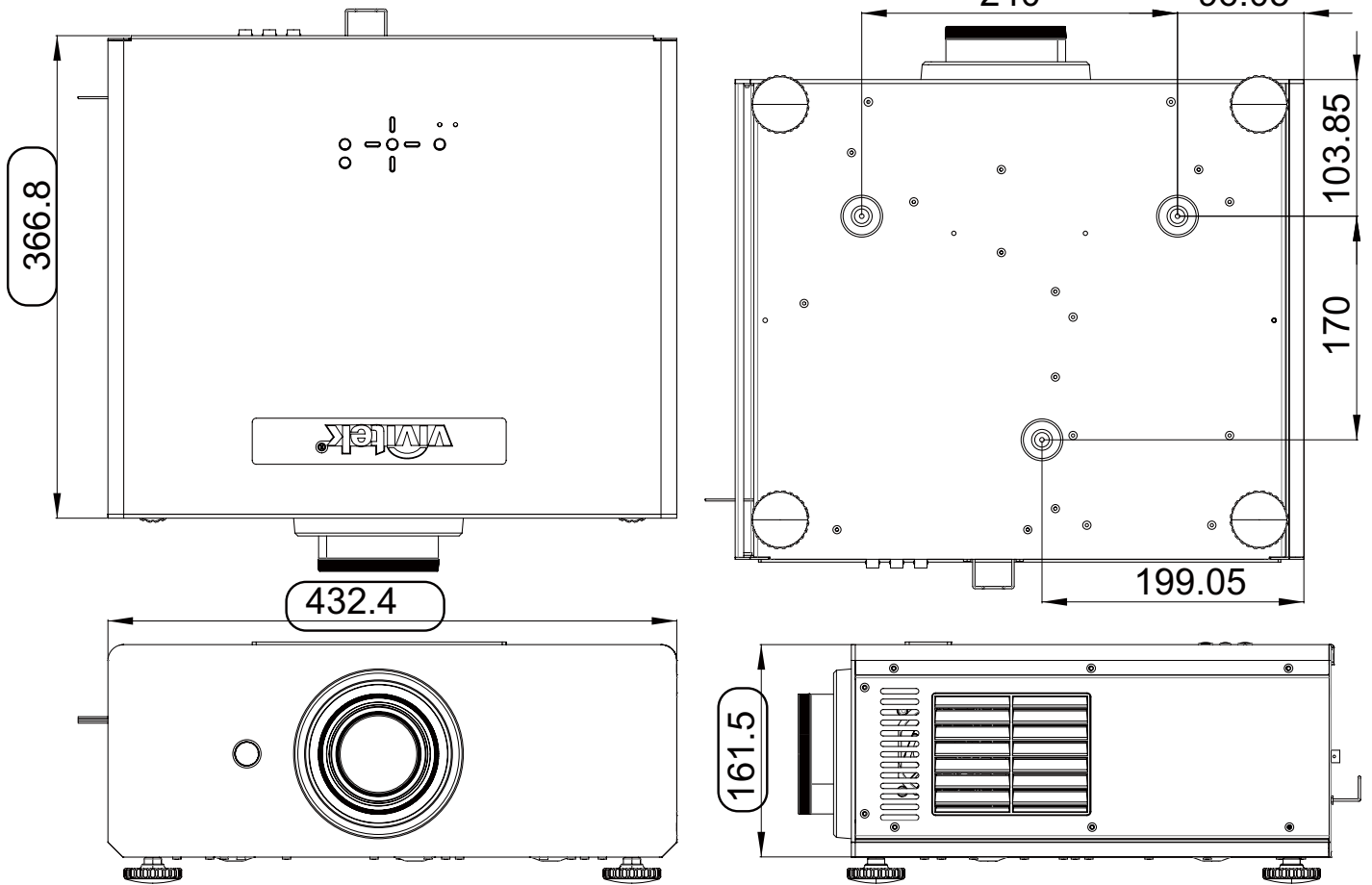

Supported Timings

Table 7-2 lists the signal types supported by each input on the H8030.

Signal Type	Resolution	Frame	Video	S-video	SCART	Y-Pr-Pb	HD15 - RGBHV	HD15 - YUV	HDMI - RGB	HDMI - 8-bit	HDMI - 10-bit	HDMI - 12-bit
PC	640x480	59.94					x		x			
	640x480	74.99					x		x			
	640x480	85					x		x			
	800x600	60.32					x		x			
	800x600	75					x		x			
	800x600	85.06					x		x			
	848x480	47.95					x		x			
	848x480	59.94					x		x			
	1024x768	60					x		x			
	1024x768	70					x		x			
	1024x768	75.03					x		x			
	1024x768	85.03					x		x			
	1280x720	47.95					x		x			
	1280x768_RB	59.995					x		x			
	1280x768	59.87					x		x			
	1280x768	74.893					x		x			
	1280x768	84.837					x		x			
	1280x800	49.954					x		x			
	1280x800	59.81					x		x			
	1280x800	74.934					x		x			
	1280x1024	60.02					x		x			
	1280x1024	75.02					x		x			
	1280x1024	85.02					x		x			
	1400x1050_RB	59.948					x		x			
	1400x1050	59.978					x		x			
	1400x1050	74.867					x		x			
1440x900	59.887					x		x				
1440x900	74.984					x		x				
1600x1200	60					x		x				
1680x1050	59.954					x		x				
1920x1080	47.95					x		x				
1920x1200_RB	59.95					x		x				
Apple Mac	640x480	66.59					x		x			
	832x624	74.54					x		x			
NTSC	NTSC (M, 4.43)	59.94	x *	x								
PAL	PAL (B,G,H,I)	50	x *	x								
	PAL (N)	50	x	x								
	PAL (M)	59.94	x	x								
SECAM	SECAM (M)	50	x	x								
SDTV	RGBS	50			x							
	480i	59.94				x						
	576i	50				x						
	1440x480i	60						x	x	x	x	
	1440x576i	50						x	x	x	x	
EDTV	480p	59.94				x	x	x	x	x	x	x
	576p	50				x	x	x	x	x	x	x
HDTV	1035i	60				x	x	x	x	x	x	x
	1080i	50				x	x	x	x	x	x	x
	1080i (Aus)	50				x	x	x	x	x	x	x
	1080i	59.94				x	x	x	x	x	x	x
	1080i	60				x	x	x	x	x	x	x
	720p	50				x	x	x	x	x	x	x
	720p	59.94				x	x	x	x	x	x	x
	720p	60				x	x	x	x	x	x	x
	1080p	23.98				x	x	x	x	x	x	x
	1080p	24				x	x	x	x	x	x	x
	1080p	25				x	x	x	x	x	x	x
	1080p	29.97				x	x	x	x	x	x	x
	1080p	30				x	x	x	x	x	x	x
	1080p	50				x	x	x	x	x	x	x
	1080p	59.94				x	x	x	x	x	x	x
	1080p	60				x	x	x	x	x	x	x

Supported Signal Timings by Input

About the Vivitek Support

If you cannot find solutions from this user guideline, please contact us using the contact information below.

North America

Vivitek Service Center
15700 Don Julian Road, Suite B
City of Industry, CA. 91745
U.S.A

Tel: 855-885-2378 (Toll-Free)
Email: T.services1@vivitekc corp.com
URL: www.vivitekusa.com

Europe, Middle East and Africa

Vivitek Service & Support
Zandsteen 15
2132 MZ Hoofddorp
The Netherlands

Tel: +31 20 655 0960
Email: support@vivitek.eu
URL: www.vivitek.eu

China

Vivitek Service Center
上海浦东世纪大道 1090 号斯米克大厦 18 层 1802 室, 201209

Tel: 400-888-3526 (Toll-Free)
Tel: 021-58360088-142 (Direct)
Email: service@vivitek.com.cn
URL: www.vivitek.com.cn

Asia and Taiwan

Vivitek after-sales service
Vivitek Corporation, Co., Ltd.
4F., No.186, Ruiguang Rd., Neihu Dist., Taipei City 11491

TEL: 86-28-797-2088
FAX: 86-26-600-2358
E-mail: kenny.chang@Vivitek.com.tw
URL: www.vivitek.com.tw